

# Jl Vulcasteel Wall

MR085 / 08 JAN 2024



Joris Ide NV is not responsible for printing errors and / or any differences between the images in this catalogue and the final product delivered. Joris Ide NV reserves the right to modify the technical specifications at any time without prior notice. To ensure that you have the latest version at hand, we invite you to scan this QR code to retrieve the latest version on our website [www.joriside.com](http://www.joriside.com).



## Index

JI Vulcasteel Wall	2
Description	2
Properties	2
System key benefits	2
Performance JI Vulcasteel Wall	3
Pressure	3
Suction	3
JI Vulcasteel Wall Alpha	4
Description	4
Properties	4
System key benefits	4
Performance JI Vulcasteel Wall Alpha	4
JI Vulcasteel Wall - Vertical application, Step 1	7
JI Vulcasteel Wall - Vertical application, Step 2	9
JI Vulcasteel Wall - Vertical application, Step 3	11
Firewall	12
JI Vulcasteel Wall - Horizontal application, Step 1	13
JI Vulcasteel Wall - Horizontal application, Step 2	15
Accessories	17
Fasteners	17
Sealants	17
Flashings and others	17

# Jl VULCASTEEL WALL

## Insulated panels

With an array of different finishes and colours the Jl Vulcasteel Wall is the solution for your projects in the agricultural, industrial, service and even residential sectors with acoustic and fire resistance requirements.

This panel is used horizontally or vertically according to personal preferences.



The Joris Ide group, with more than 3 decades of experience, processing 419.000 tonnes of steel per year and have 16 production sites in over 8 countries. With the help of more than 1230 employees Joris Ide is your dedicated partner.



## Jl Vulcasteel Wall

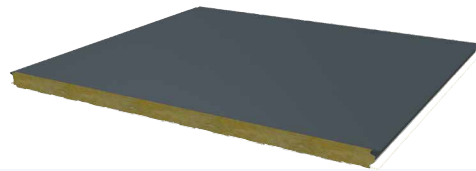

### Description

The Jl Vulcasteel Wall is a mineral wool panel with liner or microrib exterior profiling. The inner sheet is Liner profiled and 15µ PE R9002. Thanks to a high fire resistance this panel is often applied for agricultural, public or industrial projects where high fire resistance is required. This for both internal as external fire walls.

Jl Vulcasteel Wall M (microrib)

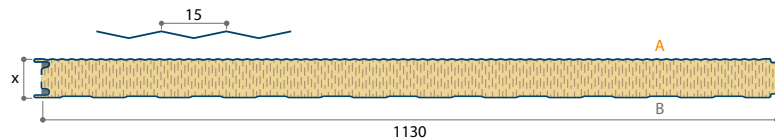

Jl Vulcasteel Wall L (liner)

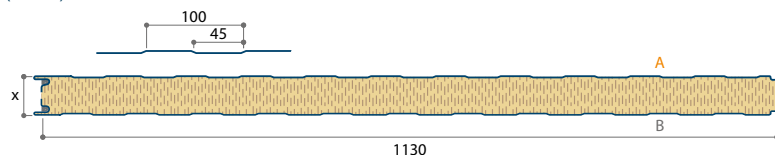

Jl Vulcasteel Wall S (smooth)

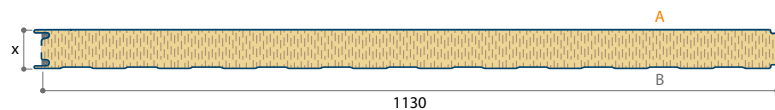

### Properties

Core thickness	mm	50	60	80	100	120	150	175	200	240
Weight	kg/m <sup>2</sup>	14,60	15,60	17,60	19,60	21,60	23,60	24,60	25,60	33,10
U-value	W/m <sup>2</sup> K	0,82	0,71	0,53	0,43	0,36	0,29	0,25	0,21	0,18
Rw (acc.)	DB	29 (-3; -6)	29 (-2; -3)	30 (-2; -3)	31 (-1; -3)	30 (-2; -5)	30 (-2; -3)	29 (-1; -5)	31 (-3; -4)	30 (-2; -6)

### System key benefits

- Non-Combustible high density mineral wool core
- Standard 1130 mm modules but available in 1000 mm
- Length up to 14 m
- Outer sheet can be Liner, Microrib or smooth profiling
- Visible fixation
- Different coatings and colours possible
- Standard in liner (microrib or smooth is an option)
- Inner sheet standard in liner profile 15µ PER9002 (smooth is an option)
- Other coatings are available on demand.
- Fire classification A2-s1, d0 according to EN 13501-1:2019
- Good thermal properties
- Vertical and horizontal application
- Fast mounting
- CE marked

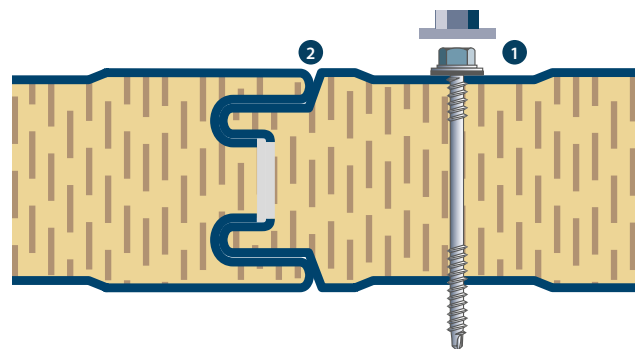

1. Visible fixation
2. In the female sockets a seal is placed in production on the inside and outside faces

# Performance JI Vulcasteel Wall

## Pressure

Span	Thickness (mm)	2,40	2,60	2,80	3,00	3,20	3,40	3,60	3,80	4,00	4,20	4,40	4,60	4,80	5,00	5,20	5,40	5,60	5,80	6,00	6,20
Single	50	1,16	1,07	0,99	0,93	0,88	0,82	0,77	0,73	0,69	0,66	0,62	0,58	0,55	0,51	0,46	0,40	0,33	0,27	-	-
	60	1,39	1,27	1,19	1,12	1,04	0,98	0,93	0,89	0,84	0,80	0,75	0,71	0,68	0,64	0,60	0,57	0,53	0,49	0,44	0,40
	80	1,68	1,55	1,44	1,35	1,25	1,19	1,13	1,07	1,01	0,97	0,93	0,89	0,85	0,81	0,77	0,74	0,69	0,65	0,61	0,57
	100	2,07	1,91	1,77	1,66	1,55	1,46	1,39	1,31	1,24	1,19	1,14	1,09	1,04	0,99	0,93	0,88	0,82	0,76	0,72	0,68
	120	1,87	1,72	1,60	1,49	1,41	1,32	1,24	1,19	1,13	1,07	1,02	0,98	0,94	0,91	0,88	0,84	0,81	0,78	0,74	0,71
	150	2,33	2,15	1,99	1,87	1,75	1,65	1,56	1,47	1,41	1,34	1,27	1,22	1,18	1,13	1,09	1,04	1,00	0,97	0,94	0,91
	175	2,33	2,15	1,99	1,87	1,75	1,65	1,56	1,47	1,41	1,34	1,27	1,22	1,18	1,13	1,09	1,04	1,00	0,97	0,94	0,91
	200	2,33	2,15	1,99	1,87	1,75	1,65	1,56	1,47	1,41	1,34	1,27	1,22	1,18	1,13	1,09	1,04	1,00	0,97	0,94	0,92
Double	50	0,99	0,93	0,86	0,80	-	-	-	-	-	-	-	-	-	-	-	-	-	-	-	-
	60	1,13	1,03	0,94	0,86	0,77	-	-	-	-	-	-	-	-	-	-	-	-	-	-	-
	80	1,42	1,31	1,21	1,13	1,06	-	-	-	-	-	-	-	-	-	-	-	-	-	-	-
	100	1,81	1,67	1,55	1,44	1,35	-	-	-	-	-	-	-	-	-	-	-	-	-	-	-
	120	1,87	1,72	1,60	1,49	1,38	1,26	-	-	-	-	-	-	-	-	-	-	-	-	-	-
	150	2,06	1,91	1,77	1,66	1,55	1,46	1,39	1,31	1,22	1,08	-	-	-	-	-	-	-	-	-	-
	175	2,06	1,91	1,77	1,66	1,55	1,46	1,39	1,31	1,24	1,16	1,09	1,01	0,87	-	-	-	-	-	-	-
	200	2,06	1,91	1,77	1,66	1,55	1,46	1,39	1,31	1,24	1,19	1,14	1,09	1,04	0,98	0,91	0,83	0,76	-	-	-
Multiple	50	0,99	0,93	0,87	0,81	0,75	0,72	0,68	0,65	0,62	0,59	0,56	0,53	0,50	0,48	0,46	0,44	0,42	0,40	0,39	0,37
	60	1,13	1,03	0,96	0,91	0,85	0,79	0,74	0,72	0,69	0,66	0,63	0,60	0,57	0,55	0,52	0,49	0,48	0,46	0,44	0,42
	80	1,42	1,31	1,21	1,14	1,07	1,00	0,95	0,91	0,86	0,82	0,77	0,74	0,71	0,69	0,66	0,64	0,61	0,59	0,57	0,54
	100	1,81	1,67	1,55	1,45	1,36	1,27	1,21	1,15	1,09	1,03	0,98	0,95	0,91	0,87	0,83	0,79	0,76	0,71	0,67	0,62
	120	1,87	1,72	1,60	1,49	1,40	1,32	1,24	1,19	1,13	1,07	1,02	0,87	-	-	-	-	-	-	-	-
	150	2,06	1,91	1,77	1,66	1,55	1,46	1,39	1,31	1,24	1,19	1,14	1,09	1,04	0,99	0,96	0,92	0,89	0,85	0,82	0,78
	175	2,06	1,91	1,77	1,66	1,55	1,46	1,39	1,31	1,24	1,19	1,14	1,09	1,04	0,99	0,96	0,93	0,89	0,86	0,83	0,80
	200	2,06	1,91	1,77	1,66	1,55	1,46	1,39	1,31	1,24	1,19	1,14	1,09	1,04	0,99	0,96	0,93	0,89	0,86	0,83	0,80

For other cases that doesn't fit within the assumptions presented above, please contact the technical assistance department of Joris Ide

## Suction

Span	Thickness (mm)	2,40	2,60	2,80	3,00	3,20	3,40	3,60	3,80	4,00	4,20	4,40	4,60	4,80	5,00	5,20	5,40	5,60	5,80	6,00	6,20
Single	50	1,16	1,07	0,99	0,93	0,88	0,82	0,77	0,70	0,64	0,57	0,50	0,40	0,30	-	-	-	-	-	-	-
	60	1,39	1,28	1,19	1,12	1,04	0,98	0,93	0,89	0,84	0,80	0,75	0,69	0,62	0,55	0,48	0,40	0,32	-	-	-
	80	1,86	1,71	1,60	1,48	1,40	1,31	1,24	1,18	1,12	1,07	1,01	0,95	0,89	0,83	0,77	0,72	0,68	0,64	0,60	0,55
	100	2,32	2,15	1,99	1,86	1,74	1,65	1,55	1,47	1,39	1,31	1,24	1,14	1,04	0,96	0,90	0,83	0,77	0,72	0,68	0,64
	120	1,87	1,72	1,60	1,49	1,40	1,32	1,24	1,19	1,13	1,07	1,02	0,98	0,94	0,91	0,87	0,84	0,80	0,77	0,73	0,69
	150	2,33	2,15	1,99	1,87	1,75	1,65	1,56	1,47	1,41	1,34	1,27	1,22	1,18	1,13	1,09	1,04	1,00	0,95	0,91	0,87
	175	2,72	2,51	2,34	2,18	2,04	1,92	1,82	1,72	1,64	1,56	1,49	1,43	1,37	1,31	1,26	1,21	1,16	1,12	1,07	1,02
	200	3,12	2,88	2,67	2,49	2,34	2,20	2,08	1,97	1,87	1,78	1,70	1,63	1,56	1,49	1,44	1,39	1,34	1,29	1,24	1,19
Double	50	0,59	0,33	-	-	-	-	-	-	-	-	-	-	-	-	-	-	-	-	-	-
	60	0,90	0,50	0,27	-	-	-	-	-	-	-	-	-	-	-	-	-	-	-	-	-
	80	1,67	1,00	0,57	0,28	-	-	-	-	-	-	-	-	-	-	-	-	-	-	-	-
	100	2,32	1,55	0,90	0,47	-	-	-	-	-	-	-	-	-	-	-	-	-	-	-	-
	120	1,87	1,68	1,25	0,68	0,29	-	-	-	-	-	-	-	-	-	-	-	-	-	-	-
	150	2,33	2,15	1,99	1,87	1,69	1,13	0,72	0,43	-	-	-	-	-	-	-	-	-	-	-	-
	175	2,72	2,51	2,33	2,18	2,04	1,87	1,53	1,08	0,74	0,50	0,32	-	-	-	-	-	-	-	-	-
	200	3,12	2,88	2,67	2,49	2,34	2,20	2,08	1,87	1,42	1,05	0,76	0,55	0,39	-	-	-	-	-	-	-
Multiple	50	1,07	0,88	0,70	0,57	0,47	0,41	0,35	0,29	-	-	-	-	-	-	-	-	-	-	-	-
	60	1,31	1,03	0,81	0,66	0,53	0,45	0,39	0,33	0,27	-	-	-	-	-	-	-	-	-	-	-
	80	1,79	1,35	1,02	0,78	0,63	0,49	0,42	0,35	0,28	-	-	-	-	-	-	-	-	-	-	-
	100	2,25	1,61	1,17	0,87	0,66	0,49	0,40	0,30	-	-	-	-	-	-	-	-	-	-	-	-
	120	1,87	1,67	1,25	0,88	0,62	0,44	0,31	-	-	-	-	-	-	-	-	-	-	-	-	-
	150	2,33	2,15	1,99	1,87	1,73	1,37	1,08	0,86	0,69	0,57	0,47	0,40	0,33	0,27	-	-	-	-	-	-
	175	2,72	2,51	2,34	2,18	2,04	1,89	1,73	1,41	1,16	0,96	0,80	0,69	0,59	0,50	0,45	0,40	0,35	0,30	-	-
	200	3,12	2,88	2,67	2,49	2,34	2,20	2,08	1,93	1,72	1,44	1,21	1,04	0,90	0,77	0,68	0,60	0,52	0,47	0,43	0,39

For other cases that doesn't fit within the assumptions presented above, please contact the technical assistance department of Joris Ide

- Span tables only valid for wall application.
- Values have been calculated using the method described in EN 14509:2013
- Deflection limit for short term loads: L/100
- The minimum required support width for end and intermediate supports is 40mm and 60mm. Larger support widths are possible. For intermediate values, linear interpolation may be used.

- Calculation of fasteners and hidden fix is not included. Maximum span width depends on the type of fixing, the number and type of fasteners as well as the support material and thickness
- In the case of double or triple span conditions, this span/load table can only be used when all spans are equal or when the difference between the spans is less than 10%.
- These span tables only consider the pressure/suction wind load.

## JI Vulcasteel Wall Alpha

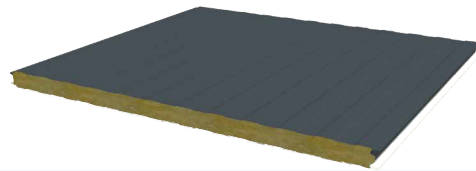

### Description

The JI Vulcasteel Wall Alpha is a mineral wool panel with liner or microrib exterior profiling. The inner sheet is Liner profiled and 15µ PE R9002. The solution for your projects in industrial, commercial, sports hall and even residential sectors with high acoustic requirements. The JI Vulcasteel Wall Alpha can be used in rooms with low or controlled humidity.

#### JI Vulcasteel Wall Alpha M (microrib)

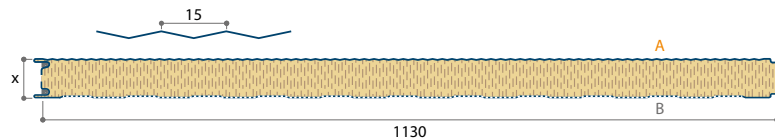

#### JI Vulcasteel Wall Alpha L (liner)

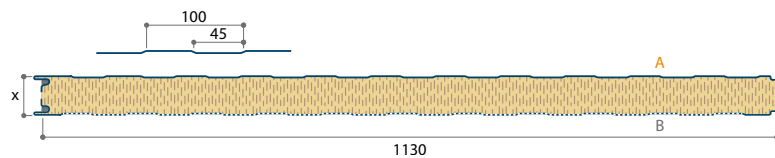

#### JI Vulcasteel Wall Alpha S (smooth)

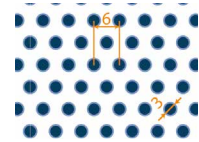
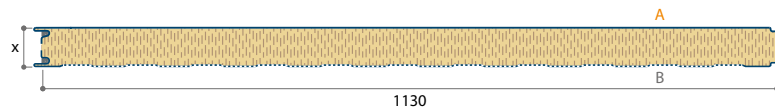

The range of products Vulcasteel Alpha has a 23% perforated inner face. Ideal to increase the acoustic absorption.

### Properties

Core thickness	mm	50	60	80	100	120	150	175	200	240
Weight	kg/m <sup>2</sup>	14,60	15,60	17,60	19,60	21,60	23,60	24,60	25,60	32,10
U-value	W/m <sup>2</sup> K	0,82	0,71	0,53	0,43	0,36	0,29	0,25	0,21	0,18
Rw (acc.)	DB	28 (-3 ; -5)	28 (-3 ; -5)	28 (-3 ; -5)	28 (-2 ; -5)	28 (-2 ; -5)	28 (-1 ; -5)	28 (-1 ; -5)	29 (-2 ; -5)	29 (-1 ; -4)
α <sub>w</sub>	-	0,80	0,85	0,90	0,85	0,85	1,00	0,95	0,95	0,95

### System key benefits

- Non-Combustible high density mineral wool core
- Standard 1130 mm modules
- Length up to 14 m
- Outer sheet can be Liner, Microrib or smooth profiling
- Visible fixation
- Different coatings and colours possible
- Standard in liner (microrib or smooth is an option)
- Inner sheet standard in liner profile 15µ PER9002 (smooth is an option). Other coatings are available on demand.
- Good thermal properties
- Vertical and horizontal application
- Fire classification NPD
- Fast mounting

### Performance JI Vulcasteel Wall Alpha

Project-specific calculations available on request.

Please contact our technical assistance department for a loads and spans verification.

## Product information

### JI Vulcasteel Wall

Classification (according to EN 13501, see page 6)

Combustibility	Smoke emission level	Flaming droplets
A2	s1	d0
	Fire resistance	Installation
JI Vulcasteel Wall 80 mm	EI 30	Vertical
JI Vulcasteel Wall 80 mm	EI 30	Horizontal
JI Vulcasteel Wall 120 mm	EI 90	Vertical
JI Vulcasteel Wall 150 mm	EI 120	Vertical
JI Vulcasteel Wall 150 mm	EI 60 / EI 120	Horizontal
JI Vulcasteel Wall 200 mm	EI 120	Vertical/Horizontal

The fire classifications above must be used under the terms mentioned on the fire reports.  
For the use of a perforated inner sheet (Vulcasteel Alpha Range) on a firewall, please contact the technical assistance department of Joris Ide.

### European Standard

European Standard EN 13501-1 provides the reaction to fire classification procedure for all products and building elements. According to this Standard, reaction to fire is the response of a product in contributing by its own decomposition to a fire which it is exposed, under specified conditions (not to be confused with the fire resistance).

Products are considered in relation to their end use application are divided into three main categories:

- Construction products
- Flooring
- Linear pipe thermal insulation products (not considered here)

## European Standard

Construction products are classified according harmonized test methods in Euroclass A1, A2, B, C, D & F. Products classified in a given class are deemed to satisfy all the requirements of any lower class. Products classified in A1 & A2 classes are non-combustible (cement, concrete, minerals, glass, fibreglass,

rock wool, ceramic, etc.), Materials certified from B to F are combustible in ascending order. Flooring materials are classified according to the same classes A1, A2, B, C, D, E & F followed by the abbreviation "fl" flooring.

## Classification according to European Standard EN 13501-1

Definition	Construction products			Floorings	
Non-combustible materials	A1			A <sub>fl</sub> 1	
Non-combustible materials	A2-s1, d0 A2-s2, d0 A2-s3, d0	A2-s1, d1 A2-s2, d1 A2-s3, d1	A2-s1, d2 A2-s2, d2 A2-s3, d2	A <sub>fl</sub> 2 - s1	A <sub>fl</sub> 2 - s2
Combustible materials very limited contribution to fire	B-s1, d0 B-s2, d0 B-s3, d0	B-s1, d1 B-s2, d1 B-s3, d1	B-s1, d2 B-s2, d2 B-s3, d2	B <sub>fl</sub> - s1	B <sub>fl</sub> - s2
Combustible materials limited contribution to fire	C-s1, d0 C-s2, d0 C-s3, d0	C-s1, d1 C-s2, d1 C-s3, d1	C-s1, d2 C-s2, d2 C-s3, d2	C <sub>fl</sub> - s1	C <sub>fl</sub> - s1
Combustible materials medium contribution to fire	D-s1, d0 D-s2, d0 D-s3, d0	D-s1, d1 D-s2, d1 D-s3, d1	D-s1, d2 D-s2, d2 D-s3, d2	D <sub>fl</sub> - s1	D <sub>fl</sub> - s1
Combustible materials highly contribution to fire	E		E - d2	E <sub>fl</sub>	
Combustible materials - easily flammable	F			F <sub>fl</sub>	

## Description

All the materials classified A2, B, C, D obtain an additional classification regarding the emission of smoke and the production of flaming droplets and/or particles.

	Definition	Level	Level definition
<b>s</b>	Smoke emission level during combustion	<b>s1</b>	Quantity/Speed of emission absent or weak
		<b>s2</b>	Quantity/speed of emission of average intensity
		<b>s3</b>	Quantity/speed of emission of high intensity
<b>d</b>	Production of flaming droplets/particles during combustion	<b>d0</b>	No dripping
		<b>d1</b>	Slow dripping
		<b>d2</b>	High dripping

Classification according to European Standard EN 13501-1. For the E class is provided one single subclass d2. For flooring products is provided the additional classification "s" for smoke emission only.



## JI Vulcasteel Wall - Vertical application, Step 1

### JI Vulcasteel Wall

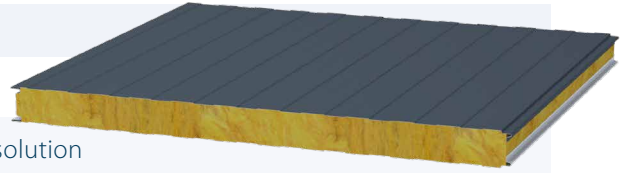

With the JI Vulcasteel Wall, Joris Ide allows for an architectural solution by combining the horizontal or vertical placed panels with accessories in different aesthetic finishes, coatings and colour throughout a wide range of external profiles. In this way the building can be designed as unique.

The JI Vulcasteel Wall can be used as a firewall when mounted in accordance to **our** fire report. The panels are to be placed as indicated with ① and ②. (Panels can be mounted upside-down starting on the opposite side depending on the predominant wind direction).



## Cladding Rails - Vertical

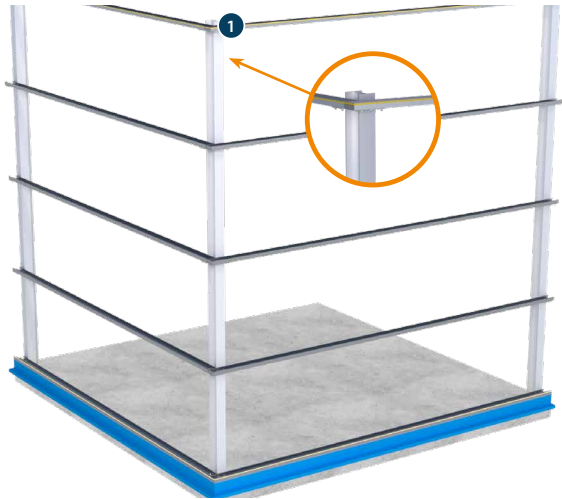

Cladding Rails fixed to cleats mounted directly on columns. 1 x strip of Butyl tape air sealant 6 mm x 5 mm **1** applied on top and bottom rails.

## Cladding Rails - Extensions



An extension of the cladding rails **2** is recommended to provide bearing for fixings of panels.

## First Panel



First panel should be installed on top of the starting piece and drip flashing (see pages 10 and 17) ensuring it is correctly fitted and installed within accepted tolerances. It will be reference to the other panels.

## First Panel - Detail

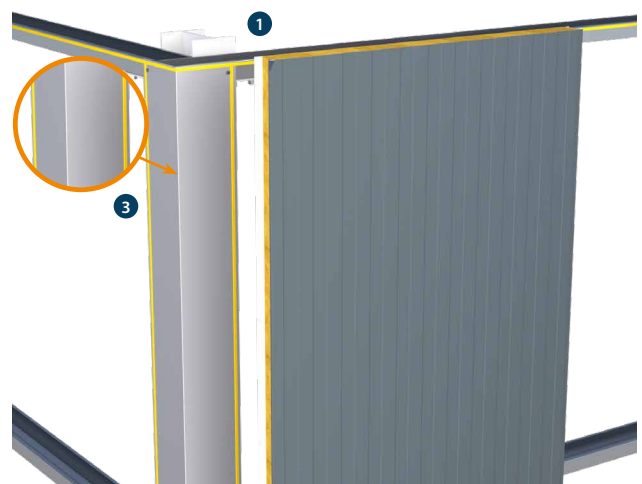

An internal flashing **3** sealed with 1 x strip of Butyl tape air sealant 6 mm x 5 mm **1**. 2 x through fixings should be used at corner position on each support. Fixings near corner may be covered by corner external flashing

*The accessories numbered with (1), (2), ...are detailed at the end of the brochure*

## JI Vulcasteel Wall - Vertical application, Step 2

Joris Ide is able to provide the best finishings for your building with a range of products that include sealants, flashings and fixings. Flashings can be ordered with the same coating and colour as the sandwich panels. Stainless steel fixings will provide resistance to the most severe environment. More info on page 17.

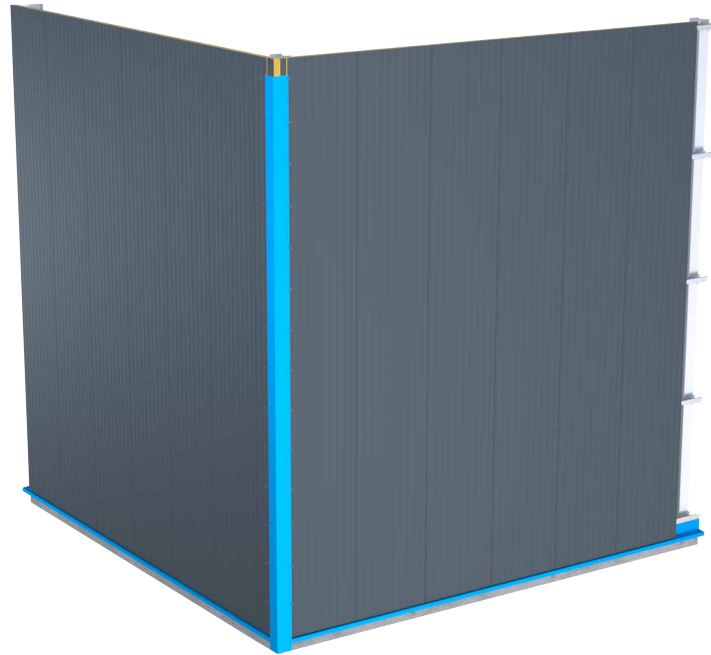

### External Corner



Complementary insulation **4** to be used on female joint of panel to fill junction. Both panels should be fixed with 2 x through fixings.

### External Corner - Finishing

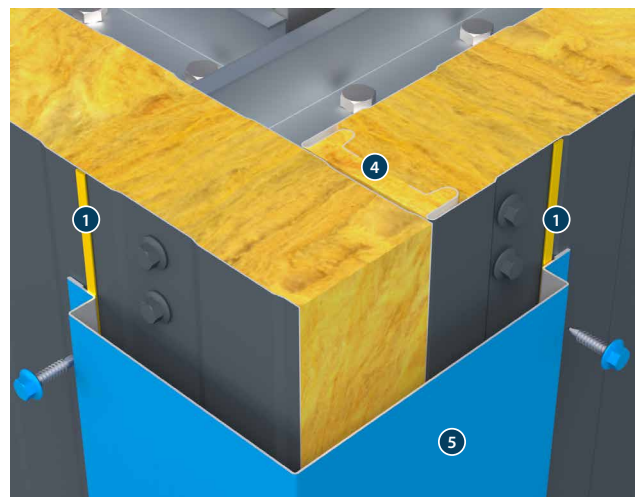

The corner flashing **5** should be fixed to both panels with stitchings at every 450 mm. A strip of butyl tape air sealant 6 mm x 5 mm **1** between flashing and panels should be used.

*The accessories numbered with (1), (2), ...are detailed at the end of the brochure*

## Side Joint



Panels to be fixed with min. 3 x main fixings (fasteners) **6** as evenly distributed as possible for that given facade.

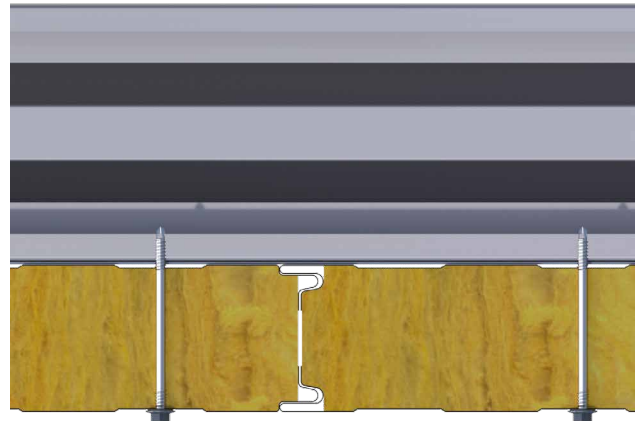

A second panel should be placed at the same level as first panel. Apply the fixings after obtaining a correct alignment.

## Closing Wall

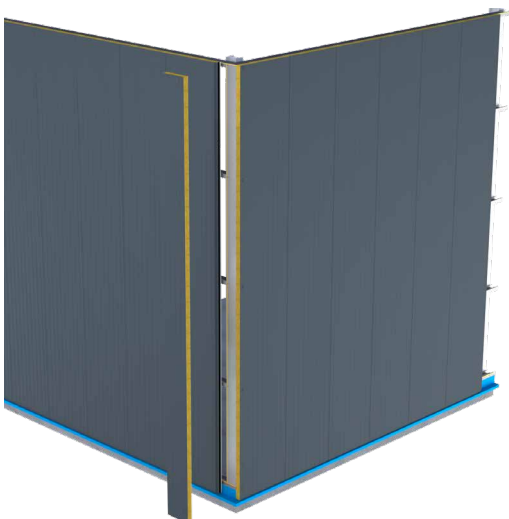

Last panel to be cut on site measured to close the corner.

## Bottom Drip

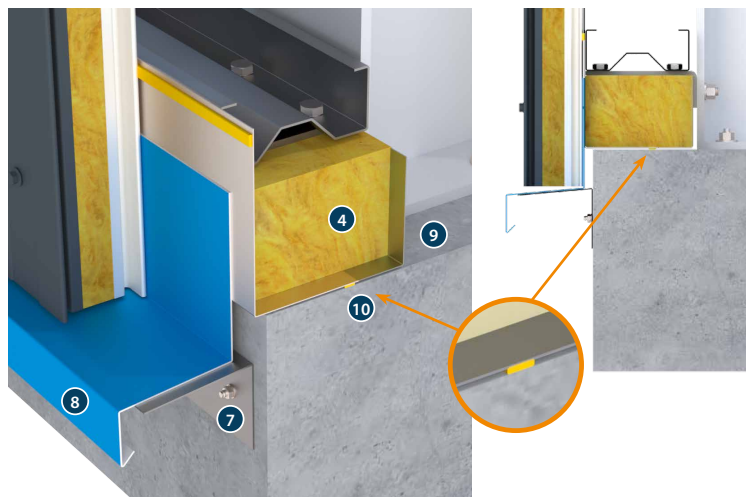

Panels should be placed at min. 5 mm from drip flashing **8**. A fire rated site-applied foam insulation **4** to be used behind closure flashing **9** to minimize the thermal bridge. A gun-grade butyl sealant **10** before placing the closure flashing. Fastener min. distance 50mm from panel's bottom. Panel's bottom min. 150mm with soft ground or min 50mm with hard ground.

*The accessories numbered with (1), (2), ...are detailed at the end of the brochure*

## JI Vulcasteel Wall - Vertical application, Step 3

### End Joint

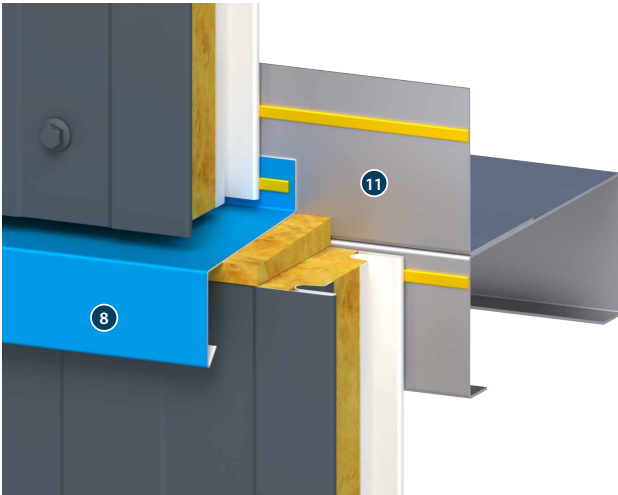

An extension to the support **11** should be fixed to the main rails to allow the bearing width to fix both panels. A drip flashing **8** should be fixed to the bottom panel.

### End Joint - Window Frame

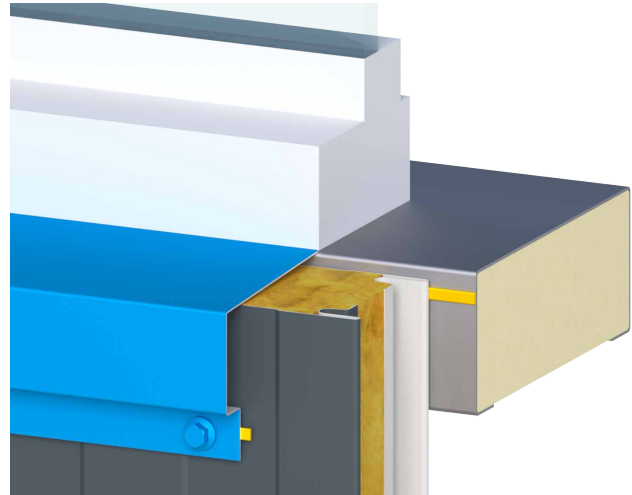

When a window frame is used at the rails level, panels should be closed and protected like in a verge detail.

### External Verge - Finishing

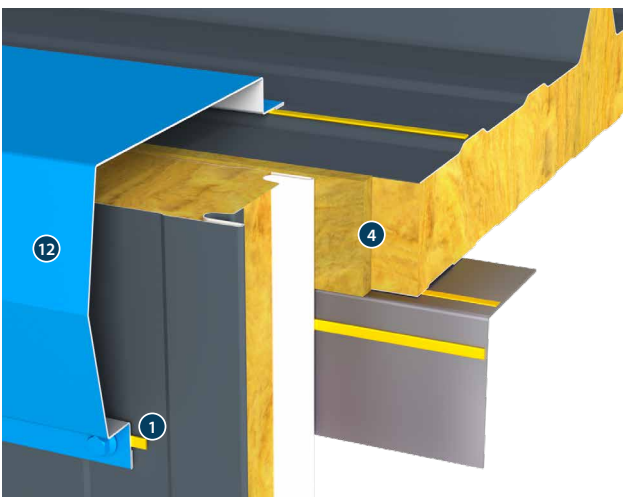

A fire rated site applied foam insulation **4** between roof and wall panels. Verge flashing **12** should be fixed to both panels with stitchings at every 450 mm. A strip of butyl tape air sealant 6 mm x 5 mm **1** between flashing and panels.



*The accessories numbered with (1), (2), ...are detailed at the end of the brochure*

## Firewall

Jl Vulcasteel Wall can be used as a firewall and will give protection from the inside or from outside when mounted in accordance with our test report. The Jl Vulcasteel Wall can contribute to the firewall with up to 120 min integrity and 120 min insulation.

### Secondary Supports / Rails\*

The secondary support system must be a 'Fire Wall' system, which contains slotted connections and nylon washers to relieve stresses induced by thermal expansion.

### Primary Fasteners\*

All primary fasteners must be the high threaded type manufactured from anti-corrosion carbon steel or stainless steel complete with washer and cap. The fixings are subject to cladding design conditions and wind loading. To comply with the requirements of BS6399: Part 2: 1997 it may be necessary to provide additional fixings in areas of high local suction.

### Side Joint - Firewall\*



*\*Or otherwise, depending on specific fire report instructions*

## JI Vulcasteel Wall - Horizontal application, Step 1

### JI Vulcasteel Wall

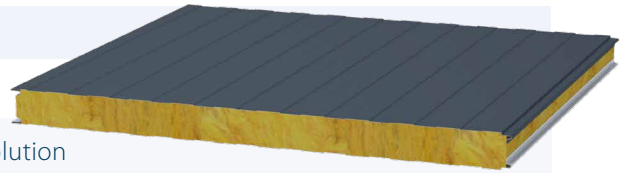

With the JI Vulcasteel Wall, Joris Ide allows for an architectural solution by combining the horizontal or vertical placed panels with accessories in different aesthetic finishes, coatings and color throughout a wide range of external profiles. In this way the building can be designed as unique.

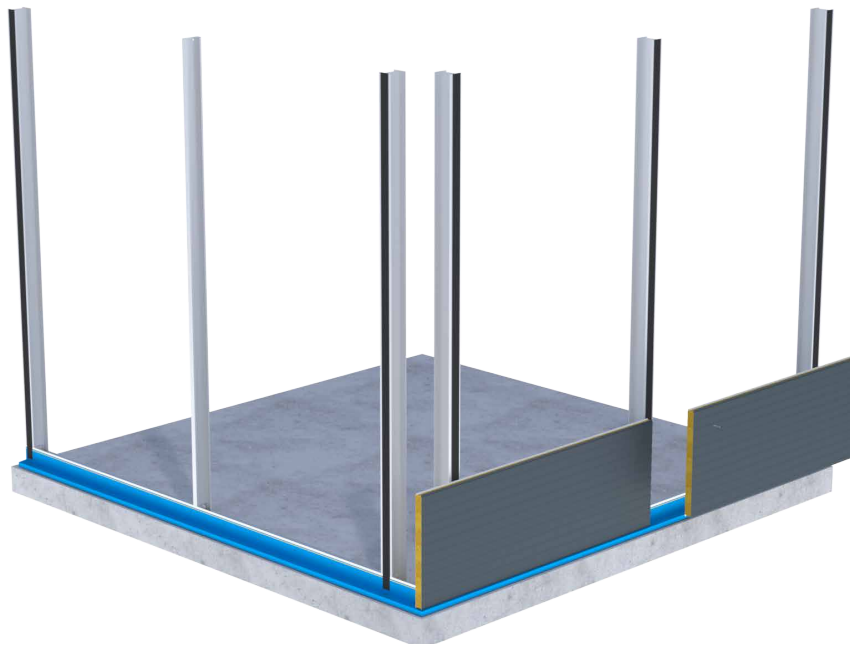

### Cladding Rails - Horizontal

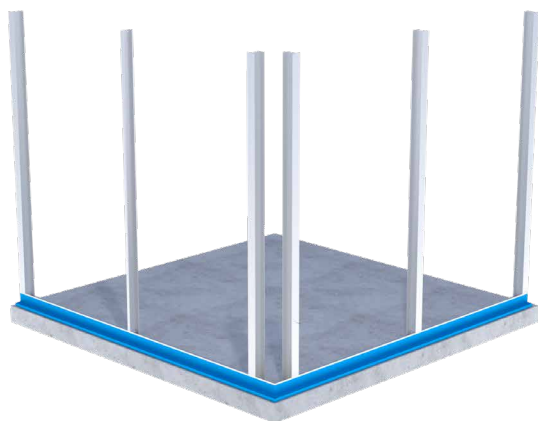

Horizontal panels can be directly fixed to the main columns without requiring secondary steelwork.

### Corner - Structural Columns

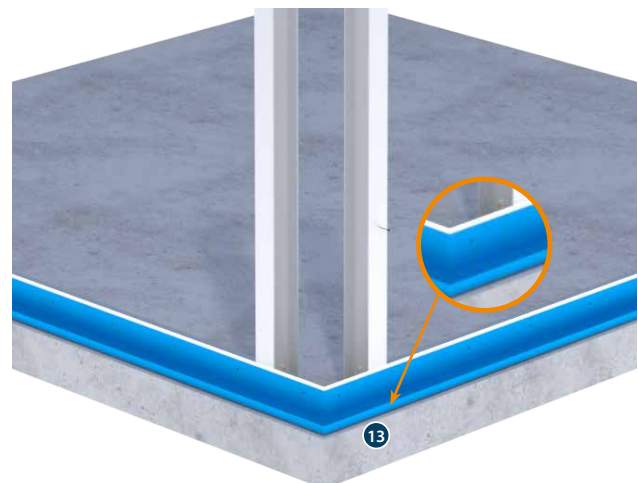

Panels bearer **13** at the female edge of panels and at max. every 1500 mm fixed to bottom structural element. This will serve as support also for the drip flashing.

*The accessories numbered with (1), (2), ...are detailed at the end of the brochure*

## Columns Arrangement - Option 1



The maximum cantilever is limited to 300 mm on a building with two columns at the corner (subject to design approval)

## Columns Arrangement - Option 2

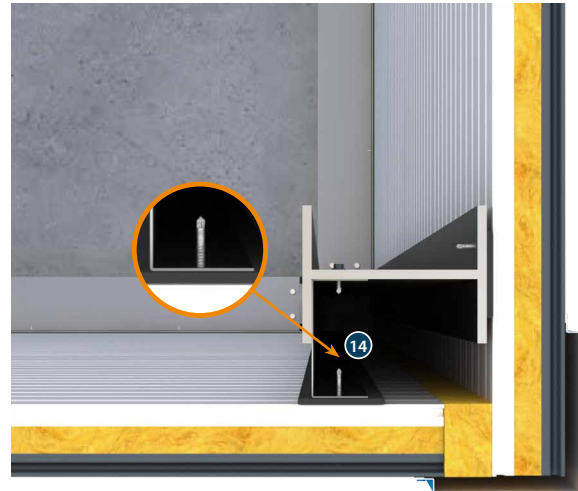

The corner column will only provide bearing support to one side/wall. A cold formed fixed to the web of the columns **14** is recommended to provide the required support to both walls.

## Bottom Drip

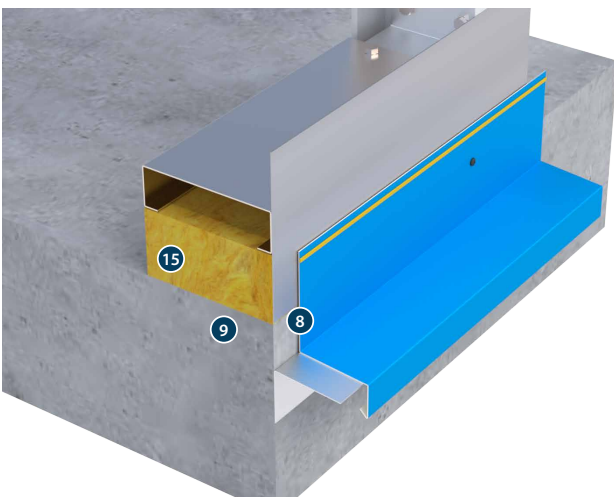

Rock wool insulation **15** and fire rated site applied foam insulation **4** to fill any gaps. An internal closure flashing **9** placed over a strip of butyl tape air sealant 6 mm x 5 mm **1**. The drip flashing **8** is fixed to the internal closure.



Before placing the horizontal panels, it is recommended to use an EPDM/butyl band **16** to protect the contact between panels and structural columns.

*The accessories numbered with (1), (2), ...are detailed at the end of the brochure*



## JI Vulcasteel Wall - Horizontal application, Step 2

Joris Ide is able to provide the best finishings for your building with a range of products that include sealants, flashings and fixings. Flashings can be ordered with the same coating and colour as the sandwich panels. Stainless steel fixings will provide resistance to the most severe environment. More info starts on page 17.

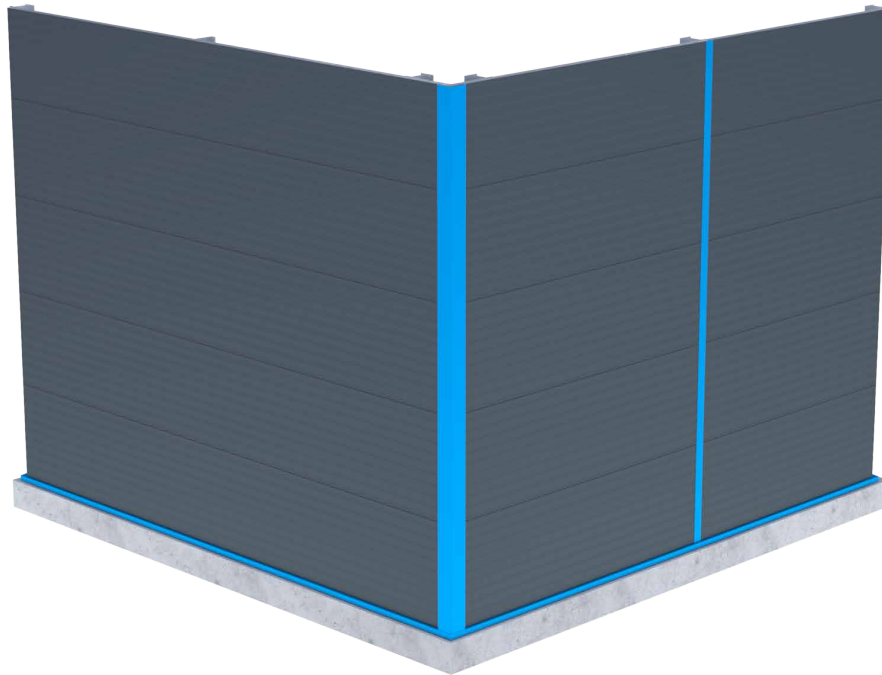

### Intermediate Support

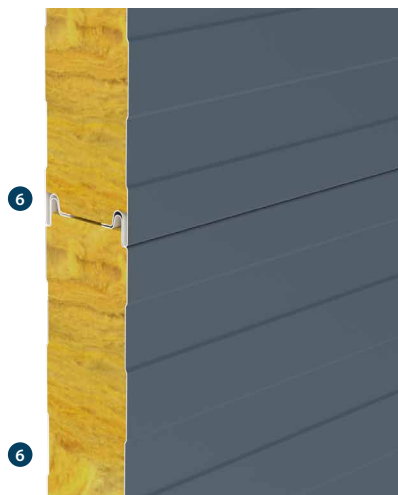

The panels must be fixed to intermediate supports with a min. of 3 main fixings (fasteners) 6 per support.

### Vertical Joint

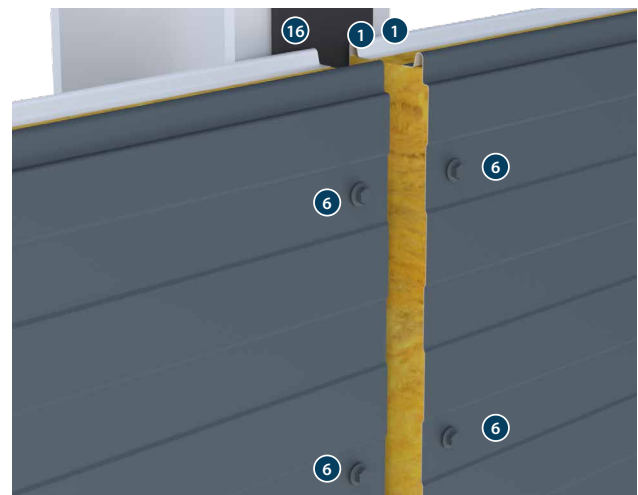

When 2 panels meet each other at one column, an EPDM/butyl band 16 is required to protect the contact between panels and structural element. Both panels are to be fixed with min. 3 main fixings (fasteners) 6 per support as evenly distributed as possible for that given facade.

*The accessories numbered with (1), (2), ...are detailed at the end of the brochure*

## Side Joint



A second panel should be mounted next to the first one.

## End Joint

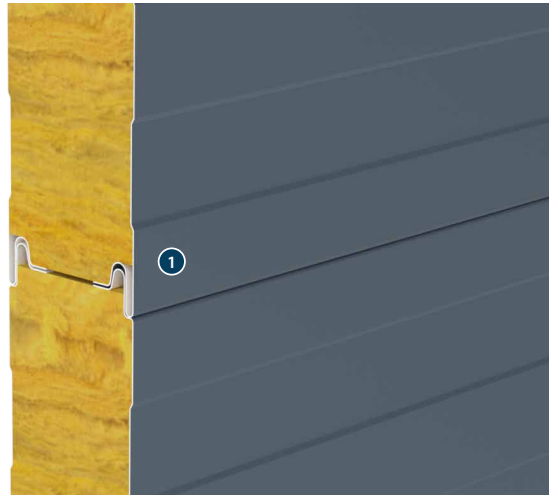

1 x strip of butyl tape air sealant 6 mm x 5 mm **1** at the end of panels to protect the intersection.

## Vertical Joint - View 1

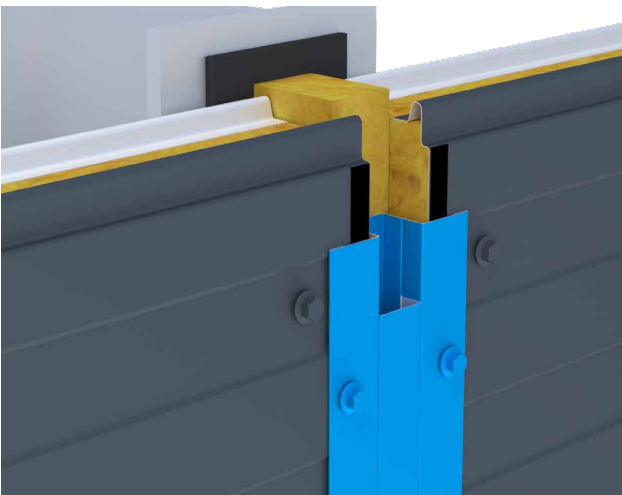

A fire rated site-applied foam insulation **4** should be used before placing the top hat that will cover the vertical joint. The contact between the top hat and the panels should be protected with 1 x strip of butyl tape air sealant **1**

## Vertical Joint - View 2

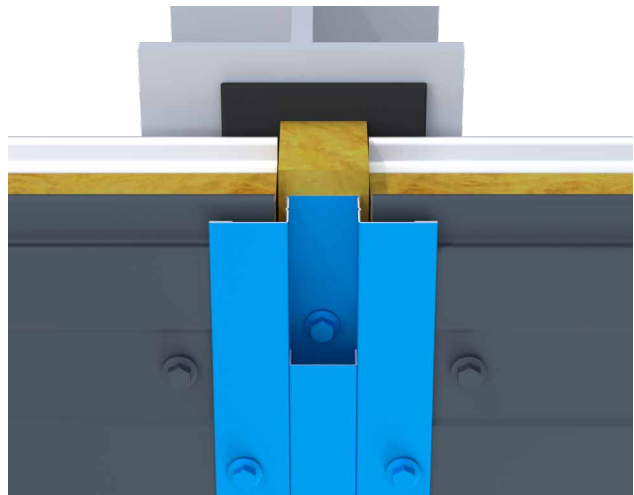

The top hat should be fixed with fixings at every 450 mm. In order to avoid the web of the columns, a minor deviation might be required to allow the fixing to pass through the flange of the structural element.

*The accessories numbered with (1), (2), ...are detailed at the end of the brochure*

## Accessories

### Fasteners

#### Steel section fasteners

Available on stock

Panel thickness (mm)	Galva Purlin (2-5mm)	Steel Beam (6-12mm)	Wooden Beam
50	4000541 - STAINLESS STEEL SCREW 5.5 x 90 AF PURLIN	4000788 - STAINLESS STEEL SCREW 5.5 x 115 AF BEAM	4000613 - STAINLESS STEEL SCREW 6.5 x 90 WOODEN BEAM AT
60	4000544 - STAINLESS STEEL SCREW 5.5 x 110 AF PURLIN	4000788 - STAINLESS STEEL SCREW 5.5 x 115 AF BEAM	4000780 - STAINLESS STEEL SCREW 6.5 x 115 WOODEN BEAM AT
80	4000624 - STAINLESS STEEL SCREW 5.5 x 130 AF PURLIN	4000789 - STAINLESS STEEL SCREW 5.5 x 135 AF BEAM	4000647 - STAINLESS STEEL SCREW 6.5 x 125 WOODEN BEAM AT
100	4000548 - STAINLESS STEEL SCREW 5.5 x 150 AF PURLIN	4000790 - STAINLESS STEEL SCREW 5.5 x 155 AF BEAM	4000615 - STAINLESS STEEL SCREW 6.5 x 150 WOODEN BEAM AT
120	4000549 - STAINLESS STEEL SCREW 5.5 x 170 AF PURLIN	4000791 - STAINLESS STEEL SCREW 5.5 x 170 AF BEAM	4000529 - STAINLESS STEEL SCREW 6.5 x 175 WOODEN BEAM AT
150	4000550 - STAINLESS STEEL SCREW 5.5 x 200 AF PURLIN	4000792 - STAINLESS STEEL SCREW 5.5 x 190 AF BEAM	4000781 - STAINLESS STEEL SCREW 6.5 x 200 WOODEN BEAM AT
175	4005089 - STAINLESS STEEL SCREW 5.5 x 240 AF PURLIN	4003937 - STAINLESS STEEL SCREW 5.5 x 245 AF BEAM	4000782 - STAINLESS STEEL SCREW 6.5 x 230 WOODEN BEAM AT
200	4005089 - STAINLESS STEEL SCREW 5.5 x 240 AF PURLIN	4003937 - STAINLESS STEEL SCREW 5.5 x 245 AF BEAM	4000533 - STAINLESS STEEL SCREW 6.5 x 260 WOODEN BEAM AT
240	On request	On request	4004901 - STAINLESS STEEL SCREW 6.5 x 290 WOODEN BEAM AT

#### FM approved fasteners

A2 Stainless Steel Fasteners	
Thickness [mm]	Light steel section (1,5 - 4 mm)
	Washer (E16)
50	JT3-6-5.5x90-E16
60	JT3-6-5.5x90-E16
80	JT3-6-5.5x110-E16
100	JT3-6-5.5x130-E16
120	JT3-6-5.5x150-E16
150	JT3-6-5.5x190-E16
175	Additional sizes can be provided upon inquiry to EJOT

### Sealants and examples of flashings



Butyl tape air sealant  
6 mm x 5 mm

High quality pressure sensitive butyl sealant  
Available in grey - 9,6 m a roll  
(reference **1** on construction details)



Fire rated site-applied foam insulation

High thermal performance insulation applied on site to reduce energy losses by thermal bridging. (reference **4** on construction details)



Gun grade butyl sealant

High quality blend of rubber, fillers and polymer in gun-grade form.  
(reference **10** on construction details)

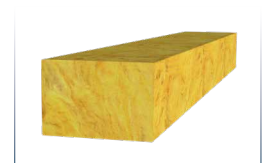

Rockwool board insulation

(reference **15** on construction details)



EPDM band

(reference **16** on construction details)

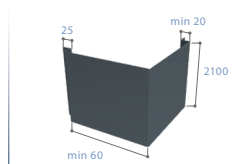

Corner flashing

Same color and finish as outer sheet  
(Option for reference **5** on construction details)

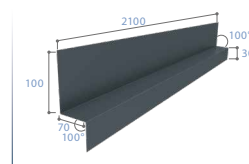

Drip flashing

Galvanized steel with the same protection as rails.  
(Option for reference **8** on construction details)

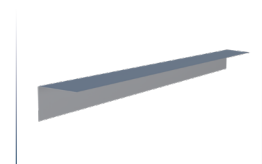

Starting piece.

(reference **7** on construction details)

**All flashings are suitable to be customized.**



Jl Vulcasteel Wall and Jl Vulcasteel Wall 1000SF next to each other.



Jl Vulcasteel Wall 1000SF in a commercial project.



Jl Vulcasteel Wall Alpha, an acoustic variation of the product.

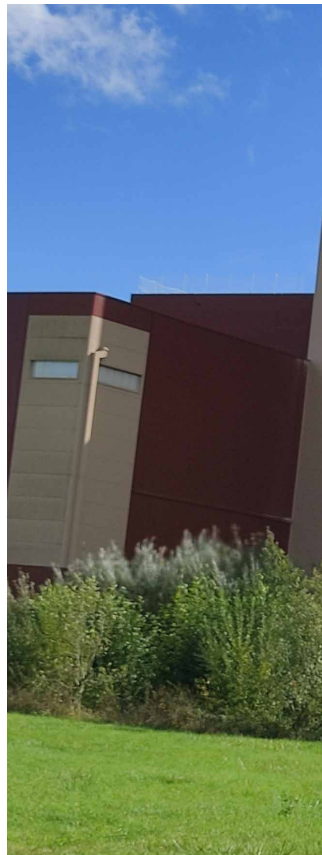



Jl Vulcasteel Wall 1000SF used in an industrial project.

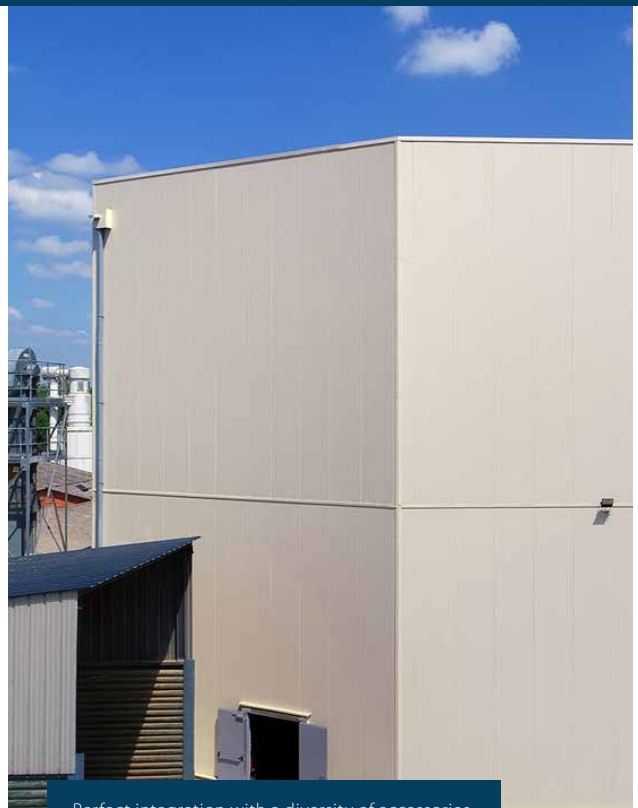

Perfect integration with a diversity of accessories.



Joris Ide proposes complete solutions for all your cladding and roofing projects.

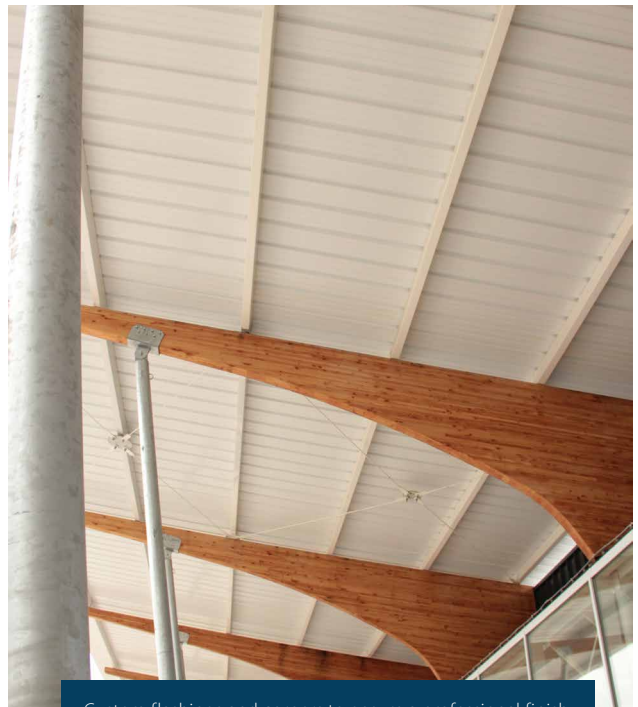

Custom flashings and corners to ensure a professional finish.

*Joris Ide NV. is not responsible for printing errors and / or any differences between the images in this catalogue and the final product delivered. Joris Ide NV reserves the right to modify the technical specifications at any time without prior notice.*



# JORISIDE

THE STEEL FUTURE

## Joris Ide Ltd.

A9, Elmbridge Court,  
Gloucester GL3 1JZ, United Kingdom

☎ +44 (0)1452 412 069

☎ +44 (0)1452 358 025

✉ [sales@joriside.co.uk](mailto:sales@joriside.co.uk)

## Joris Ide nv/sa

Hille 174,  
8750 Zwevezele, Belgium

☎ +32 (0)51 61 07 77

☎ +32 (0)51 61 07 79

✉ [info@joriside.be](mailto:info@joriside.be)



With more than 30 years of experience, Joris Ide represents a guarantee of quality in the construction market. We provide solutions in all fields: acoustic, aesthetic, fire, thermal. Joris Ide, the essential partner for all your projects.



JORIS IDE IS  
**PLANET  
PASSIONATE**

