



HANDLING AND STORAGE

An illustrated guide

MR052 / 0321

JORISIDE
THE STEEL FUTURE

HANDLING AND STORAGE

Index

Organisation and set-up of the construction site	2
Our recommendations	2
Handling equipment and protective equipment	4
Personal protective equipment	5
Packaging & packing	8
Sandwich panels	8
Roof profiles and trays, roofing and wall cladding	8
Precautionary measures	9
Transport	10
Unloading – profiles and trays	11
Unloading – sandwich panels	12
Spread angle of chain slings	13
Storage	14
Provisions for profiles, trays and sandwich panels	14
Protective film	16
Handling	17
Use of a lifting beam	18
Supply	19

An illustrated guide

The steps in the run-up to the use of products for the metal cladding of a building have an impact on the quality of this cladding. These are vital because they can possibly alter the product's performance and/or appearance.

The unloading, handling and storage of sandwich panels or corrugated sheeting must be carried out without causing any permanent deformation (absence of defects in

shape) or degradation, that could affect the corrosion resistance of the materials used and the appearance of the products.

We wish to remind the project manager and any person involved in the handling of our products of how important it is to define specifications for the places where packages are loaded, stored and distributed and for the handling and lifting thereof in the tender specifications.



Use of sandwich panels for cladding.



Installation of Mineral Wool panels in progress.

The tender specifications must also set out the provisions for the storage of packages and products. Failing this, the project manager and the contractors can jointly agree on these provisions.

This illustrated guide provides an overview of our recommendations for the handling and storage of our products, to promote the adoption by contractors of good practices and of the key provisions set out in our Technical Application Documents, in building codes, in professional recommendations, etc.

This document does not replace the reference texts that are applicable to our products (TAD, Building code, professional recommendations...).

Joris Ide NV cannot be held responsible for printing errors and / or differences between the images in this catalogue and the final product supplied. Joris Ide NV reserves the right to modify the technical specifications at any time and without prior notice.



Organisation and set-up of the construction site



The preparation of the construction site can have an impact on the handling and storage phases, after the products are delivered to the site. Well-marked-out and prepared areas and access routes, adequate personal protective equipment, and appropriate material all help ensure that everything goes smoothly on the construction site.

The proper organisation of supplies to site and on-site handling ensure that the objectives of all the parties involved (principal, project manager, coordinator, contractors, etc.) are coordinated when it comes to:

- Reducing the risk of accidents;
- Efficiency and quality gains;
- Perpetuating the image of the building profession.



⚠ Our recommendations

The storage areas must be marked out and situated at a good distance from the electrical facilities.

The access routes to the storage areas and lifting/handling areas are stabilised and have a minimum width of at least 3 metres.

The area surrounding the building must not be uneven to ensure that the handling/lifting equipment (crane, platform, etc.) can move around freely.



How the site shall be supplied is set out in texts of a regulatory or contractual nature.

These texts are taken from the Labour Code, environmental, construction, town planning, or quality management regulations.

Collective handling equipment must be available, in agreement with the principal, to be provided by the coordinator.

A specific “logistics/handling” lot must be included in the contract documents of the tender. Failing this, a company that will be in charge of all collective handling equipment must be designated.

The coordinator must remind the various parties involved that all equipment and machinery must be operated by workers holding a valid driving license (cf. CACES (safe driving aptitude certificate), etc.).

Handling equipment and protective equipment



The lifting/handling equipment must be adapted to the package and the products to avoid their degradation.

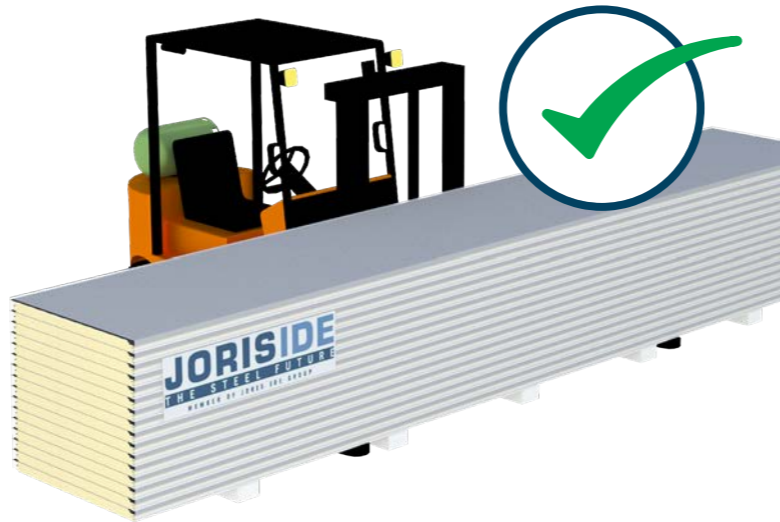
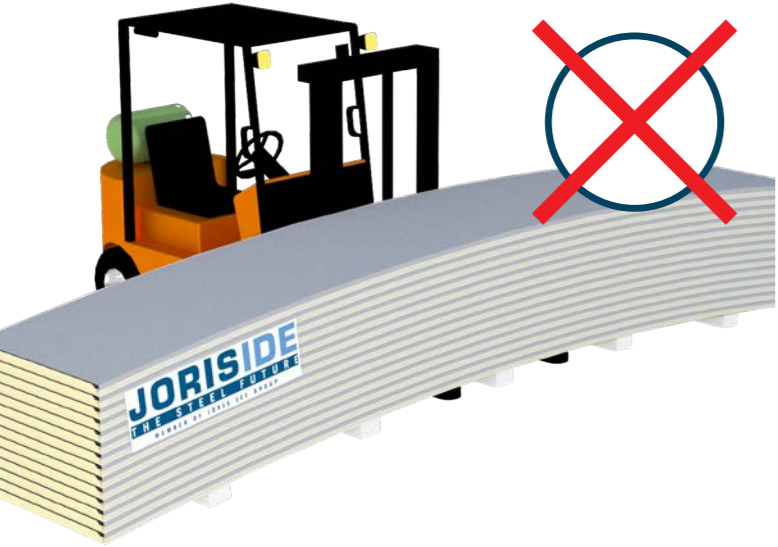

Unloading and handling must take place without causing:

- Permanent deformation (absence of defects in shape) ;
- Degradation that may affect the corrosion resistance of the materials used and the appearance of the cladding to be installed.

ARE YOU PROTECTED?

Personal protective equipment



Compliance with the standards and regulations regarding PPE is crucial. Our recommendation is to also take into account the comfort and adaptability of the PPE, in accordance with the work to be carried out:

- Harness;
- Hearing protection;
- Helmet;
- Protective goggles;
- Gloves;
- Protective clothing;
- Safety shoes, etc.

Our advice: check the PPE guide published by the OP-PBTP for further information, that is in line with European legislation and the Labour Code.



Packaging & packing

The packaging of our products is designed to be handled with a forklift or a lifting beam of the appropriate dimensions.

Sandwich panels

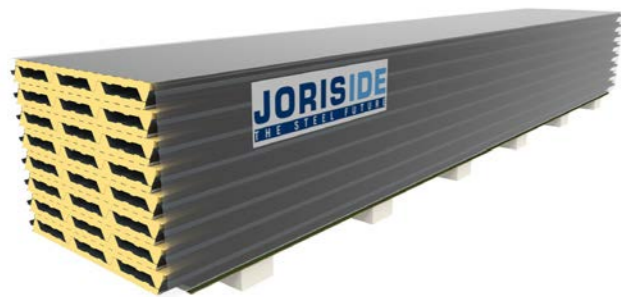

Our roof sandwich panels are stacked on plates (e.g., expanded polystyrene in the case of our JI Vulcasteel Roof). The latter are then placed on polystyrene blocks, enabling the stacking of the package. The upper face of the last panel is covered with polystyrene plates and the entire package is wrapped with stretch film.

Our sandwich panels for cladding are packaged in the same way. In the case of our façade cladding mineral wool sandwich panel with hidden fixture (JI Vulcasteel Wall 1000SF) and insulating core, the panels are stacked to a maximum height of 70 cm.

On request, the outer face of the last JI Roof PIR panel can be placed at the top of the package to facilitate unloading with a suction cup lifting beam (outer sheet of top panel facing up).



Roof profiles and trays, roofing and wall cladding

Our roof profiles and trays, roofing and wall cladding are stacked (upside down on top of each other in the case of the trays) - and packed in heavy film when pre-lacquered - on spacers to facilitate stacking of the package.

Supplementary spacers are then placed on the stack, combined with a metal strap to keep the package together.

Precautionary measures

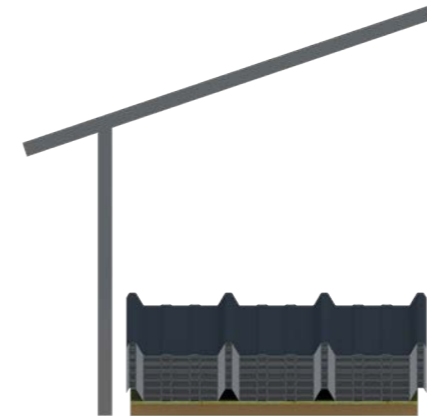

Store your profiles dry. Under a shelter is a good, but only temporary solution.

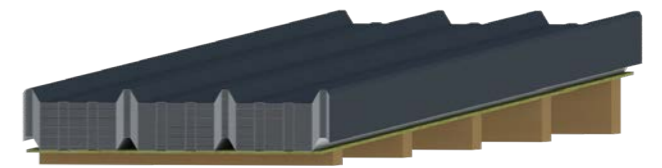

When stored in the open air: provide a slope so that no water can collect between the profiles.

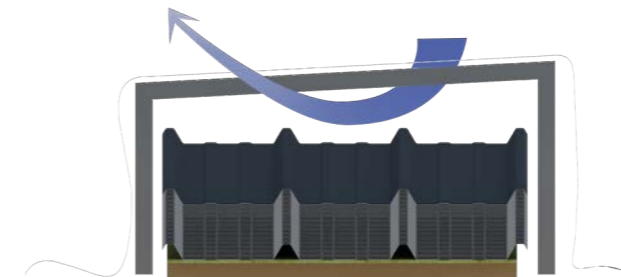

On construction site preferably store under a tarpaulin and provide adequate ventilation.

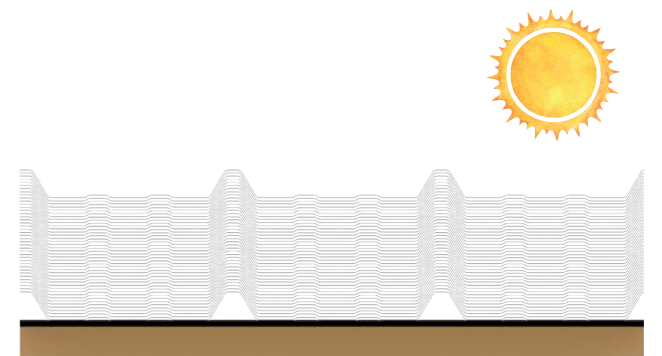

Rooflights should never be exposed to the sun when stacked. Always store under a tarpaulin.

⚠ Long-term storage (from 1 month) must be done indoors and moisture-free!

Transport

Unloading – profiles and trays



Transport of the products must be done in conditions that ensure the integrity of the initial product characteristics, while preserving packages from humidity and the consequences thereof (oxidation, etc.).

Upon delivery, the buyer must inspect the products, comparing the number, the dimensions, the weight and conformity with the information provided on the order confirmation/delivery note. He must then record any visible damage on the delivery note and the CMR note.

The buyer's unconditional acceptance means that the delivery that he accepted fully complies with the information on the order confirmation or delivery note.

In the event that the buyer has reservations about product or concerns about a deviation from the contents of the order confirmation, he must send a detailed and motivated complaint to the seller, by registered letter, within **72 hours** after the product was delivered to him.

Because they will be used on a building, special attention must be paid when stacking and securing packages.

Unloading packages of profiles and trays can be done as follows:

- With a forklift. The spacing and length of the forks must be adapted to the package (weight, dimensions);
- With cranes fitted with a lifting beam.

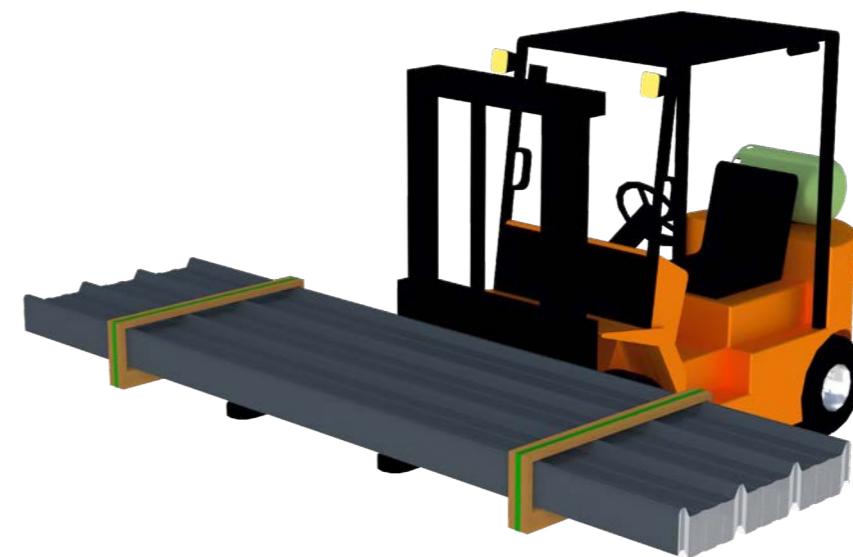

Unloading profiles and trays with a forklift must be done in the same way as for sandwich panels (see page 15). It is worth remembering, however, that wooden planks must be placed between the forks and the products.

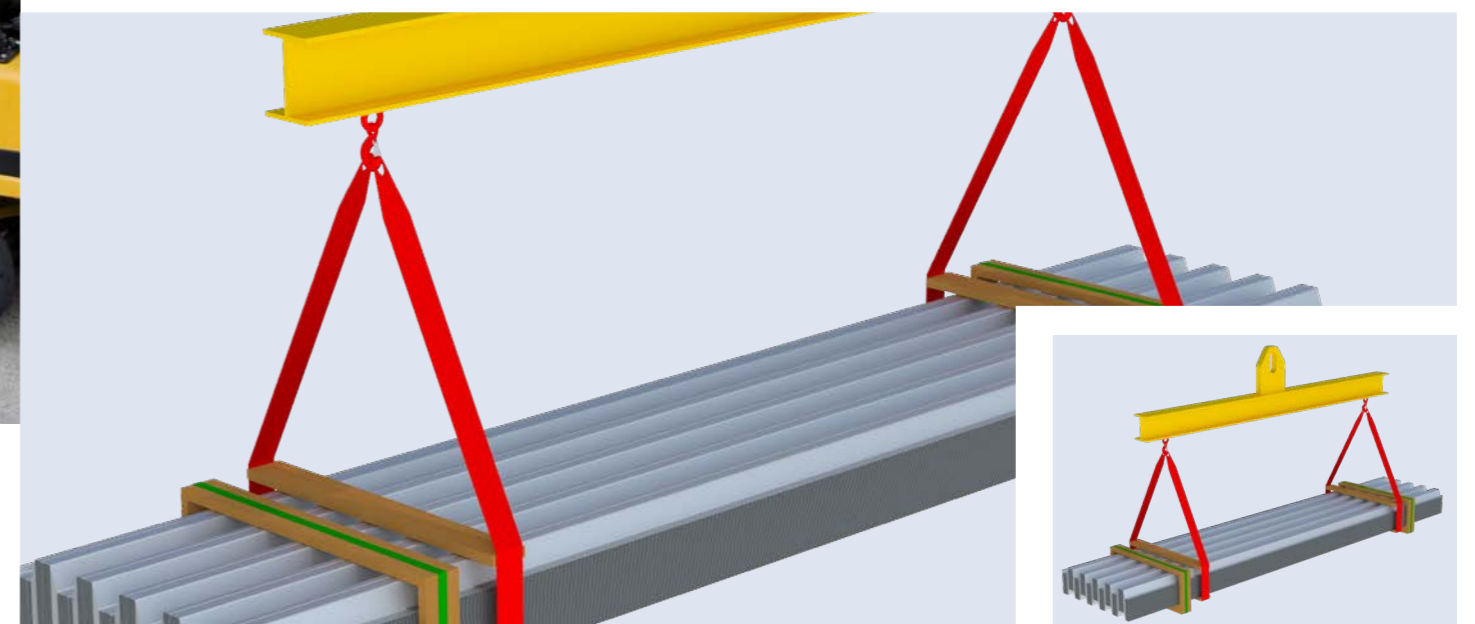

Unloading packages of profiles and trays with a crane is done in the same way as for sandwich panels.

Wooden planks must be inserted between the package and the slings to protect them against the sharp edges of the sheets.

Unloading – sandwich panels

Because the panels will be used on a building, special attention must be paid when stacking and securing packages.

When unloading with a forklift, the spacing, positioning and length of the forks must be adapted to the package's weight and dimensions.

The use of lifting equipment means you must protect the edges of the panels and the inside face of the packaging against the lifting arms (e.g., edges of the forks against the edges of the packages).

Length ≤ 6 m: distance between the forks must be adapted to the length (overhang between the forks and the end of the panel < 2 m).

Length 6 to 10 m:

- Use of a wide apron: spacing of the forks, and the arms if more than 2 forks, approx. 4 m;
- Use of an XL apron: spacing of the forks, and the arms if more than 2 forks, approx. 6 m.



Spread angle of chain slings

The greater the angle formed by the slings, the greater the forces in the slings and the more their bearing capacity will decrease.

Capacity is reduced by 15% at a 60° angle; by 33% at a 90° angle and by 50% at a 120° angle.

Where possible, we recommend that the sling angle be between 30° to 45°.

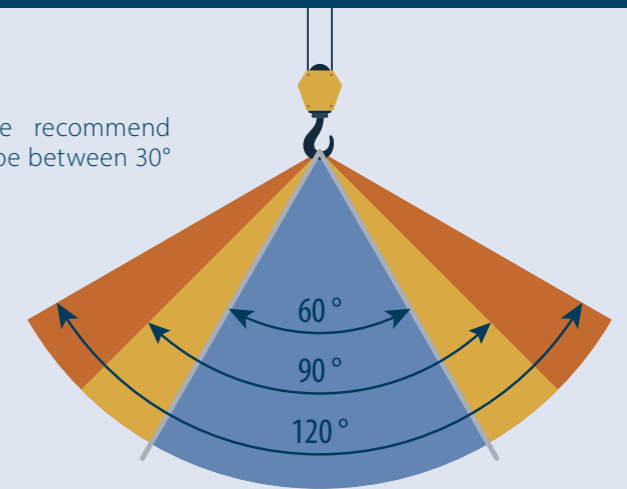

⚠ Packages containing products with different lengths: in this case, the positioning of the forms must take into account the fact that the centre of gravity is off-axis from its centre.

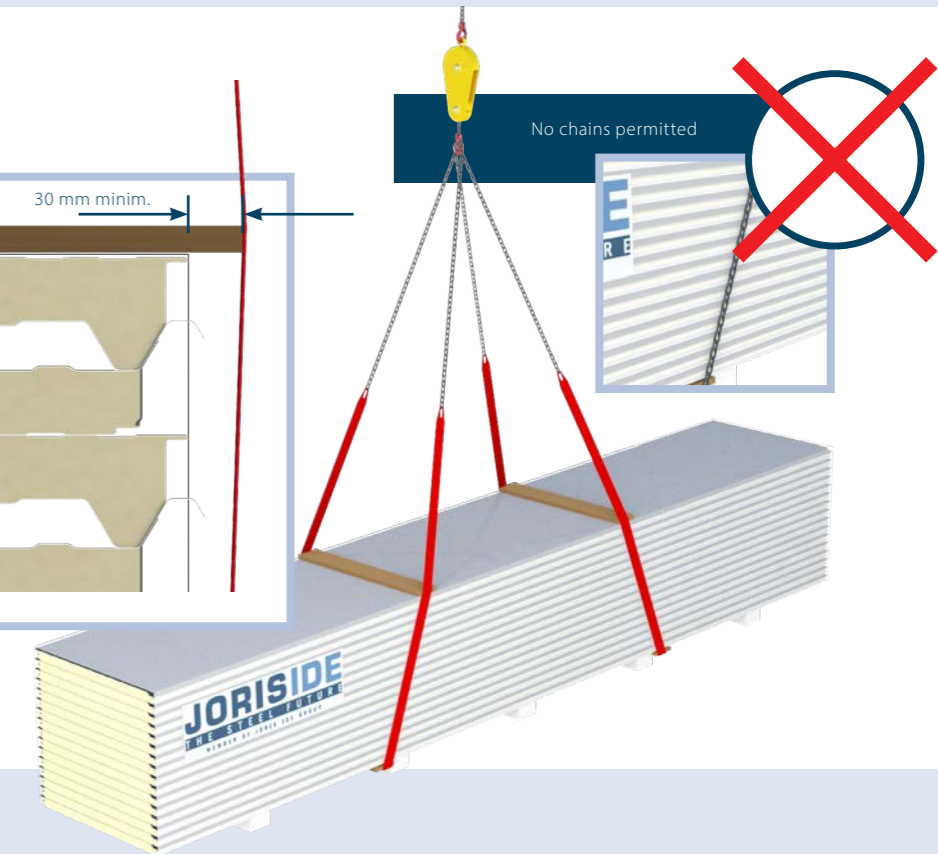
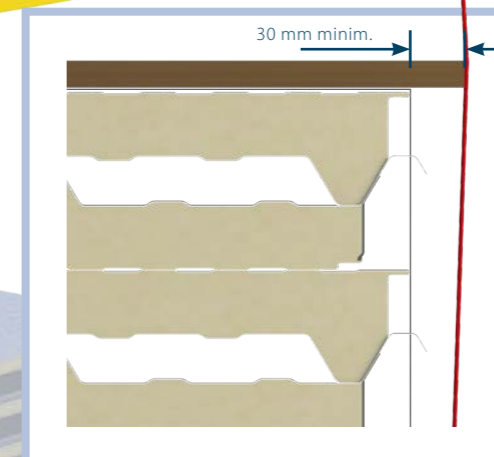
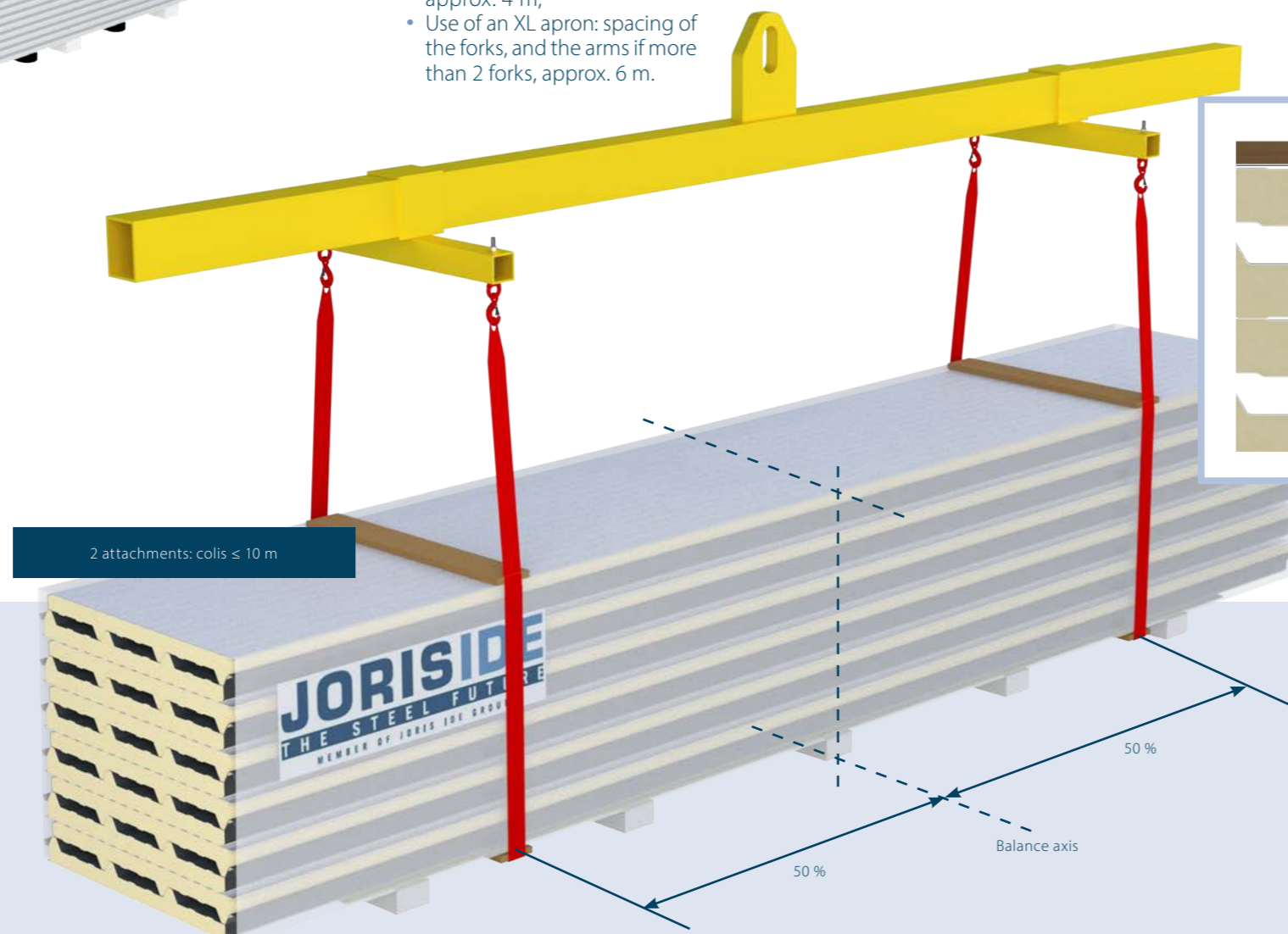

Packages exceeding 6 m and/or in the absence of a forklift with a wide or XL apron: it is recommended that you unload the package with a (fixed or mobile) crane, using a lifting beam with 2 attachments for lengths up to 10 m and 4 attachments for longer packages.

Flat slings only, that are 150 mm wide ideally, and pass them under the wooden planks. To avoid any deterioration of the edges of the products and the slings, we recommend that you arrange rigid sheet wood on the package in line with the sling

and protruding on either side of the package by at least 30 mm.

The overhang and the centre distance between the slings must never exceed 3 metres.

Storage

Provisions for profiles, trays and sandwich panels

The galvanised steel or pre-lacquered galvanised steel profiles, trays and panels, which are stacked in packages, are extremely susceptible to humidity and condensation, as a result of a change in environmental conditions. This may

give rise to grey or whitish deposits which are commonly called

“white rust”. It may even cause migration under the coating causing it to peel off after prolonged storage.

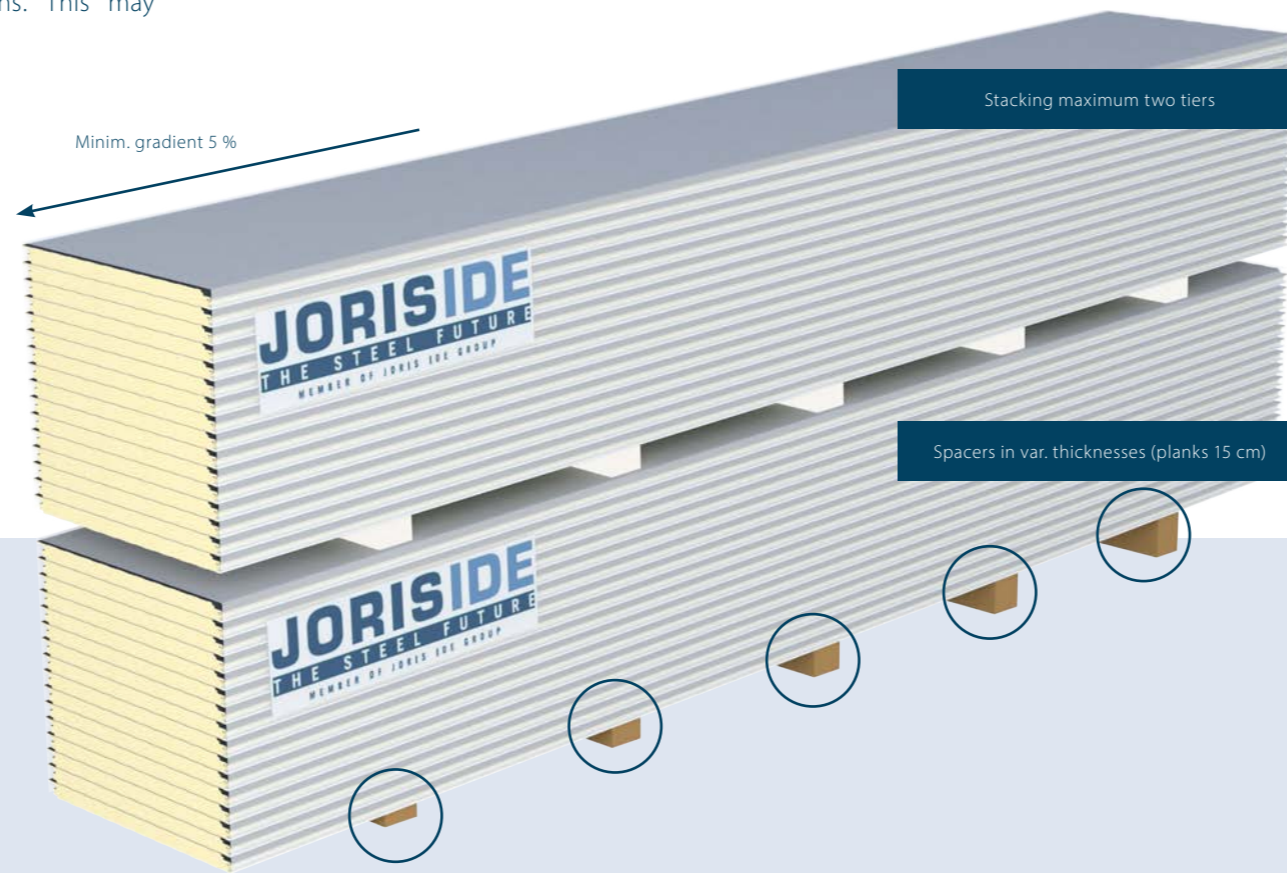

In the storage area, all the packages must be tilted lengthwise, using wedges of different thicknesses (boards that are at least 15 cm wide), to facilitate the flow of water and the evacuation of condensate. The wedges between the ground and the packages must create sufficient space to allow for proper ventilation while avoiding permanent deformation of the products.

Ideally the packages must be tilted at a 10% angle. The angle must never be less than 5%.

When packages cannot be stored in sheltered storage spaces, they must be covered and tilted, as explained opposite, always on stable and dry ground.

In that case, arrangements must be made (holes, flaps, etc.) to ensure the ventilation of the packages.

Products coated with a condensation regulator must be stored away from frost, direct sunlight and high heat. No moisture should penetrate between the sheets in a package. Foresee a minimum angle of 20% for this type of product.

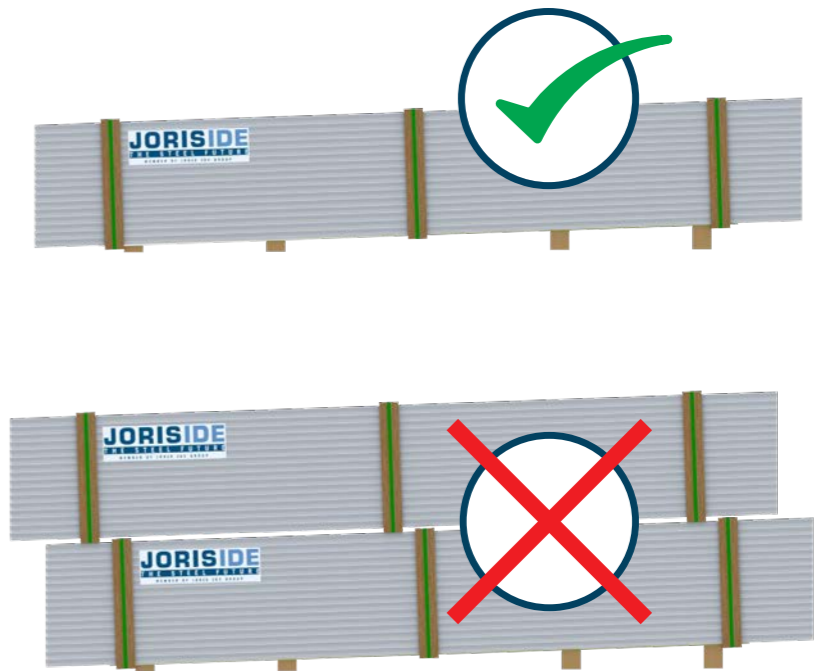
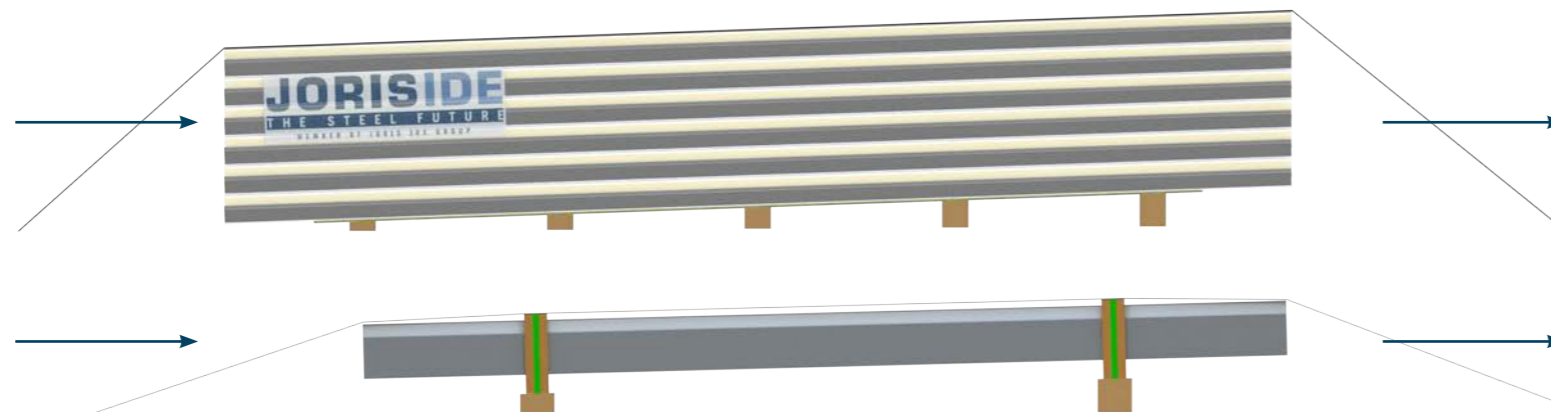

The products must be stored on-site, on a stable and dry underground, in a ventilated storage space (covered storage space, shed, covered section of the building, etc.), out of the sun, rain, snow, and any harmful vapours.

The packages of our mineral wool sandwich panels are protected by a polyethylene film that is designed to protect them against the rain during unloading, for a maximum storage period of 1 month.

We recommend regular inspections of the packages, especially if they are to be stocked for more than 1 week.

Wet or humidified products must be dried separately as soon as possible, to avoid any damage to the coatings or the insulation.

⚠ Modifications to and changes of on-site storage locations must be avoided because of possible degradation. minimum, unless specifically otherwise mentioned in this document, i.e., **1 month** starting from the delivery date.

Regardless of which Joris Ide product you are using, the storage period must always be reduced to a

Storage

Protective film

Protective film is used to cover the surfaces of some of our pre-lacquered products. This film can be peeled off.

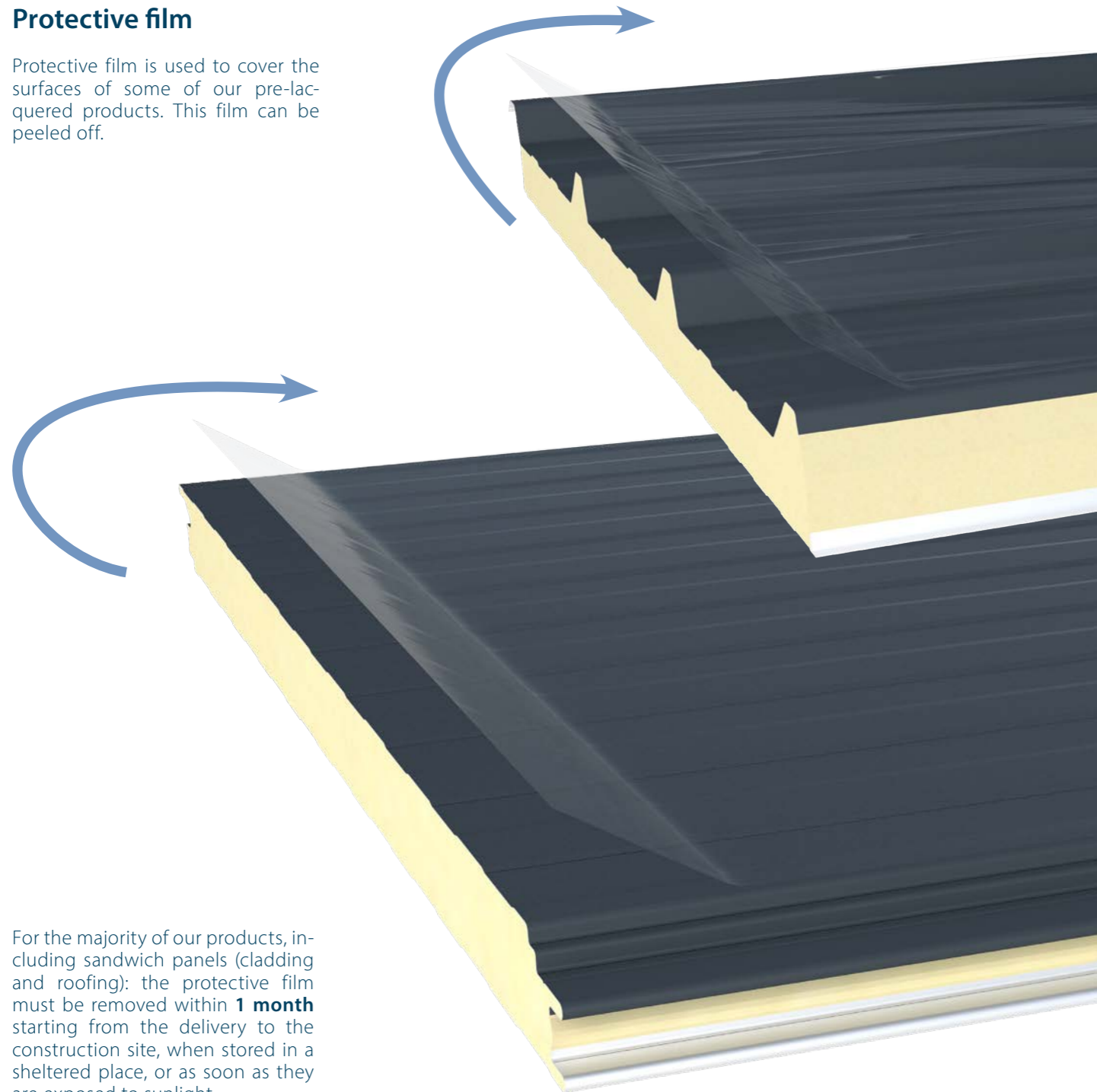

For the majority of our products, including sandwich panels (cladding and roofing): the protective film must be removed within **1 month** starting from the delivery to the construction site, when stored in a sheltered place, or as soon as they are exposed to sunlight.

If this limit is exceeded, the protective strips that cover the pre-lacquered trays must be removed no later than one month after the shipment left the factory (and before use).

The protective film covering the products in our **Façade range** must be removed no later than **2 weeks** after delivery to the site.

Handling

The handling operations must be carried out, taking into account the specifications of these products.

When unstacking, lift the products, to prevent rubbing of the facings and deformation of the edges (interlocking, free longitudinal rib).

To do this, a person should stand at either end of the product.

The handling of products during their transport from the storage space to the place where they are to be installed, is done on edge.



You must avoid gripping sandwich panels by the edges. They should preferably be gripped on edge with the male side (interlocking) facing down. Tilting relatively long panels on edge in relation to their thickness ($L > 100 \times \text{thickness}$) is crucial to prevent them from being ruined.

Handling

Supply

Use of a lifting beam

Due to the significant mass of the sandwich panels and for any package over 70 kg, we recommend using a lifting beam with suction cups or a magnetic lifting beam, that is attached to a crane, for all handling operations (weather to weather stacking is recommended).

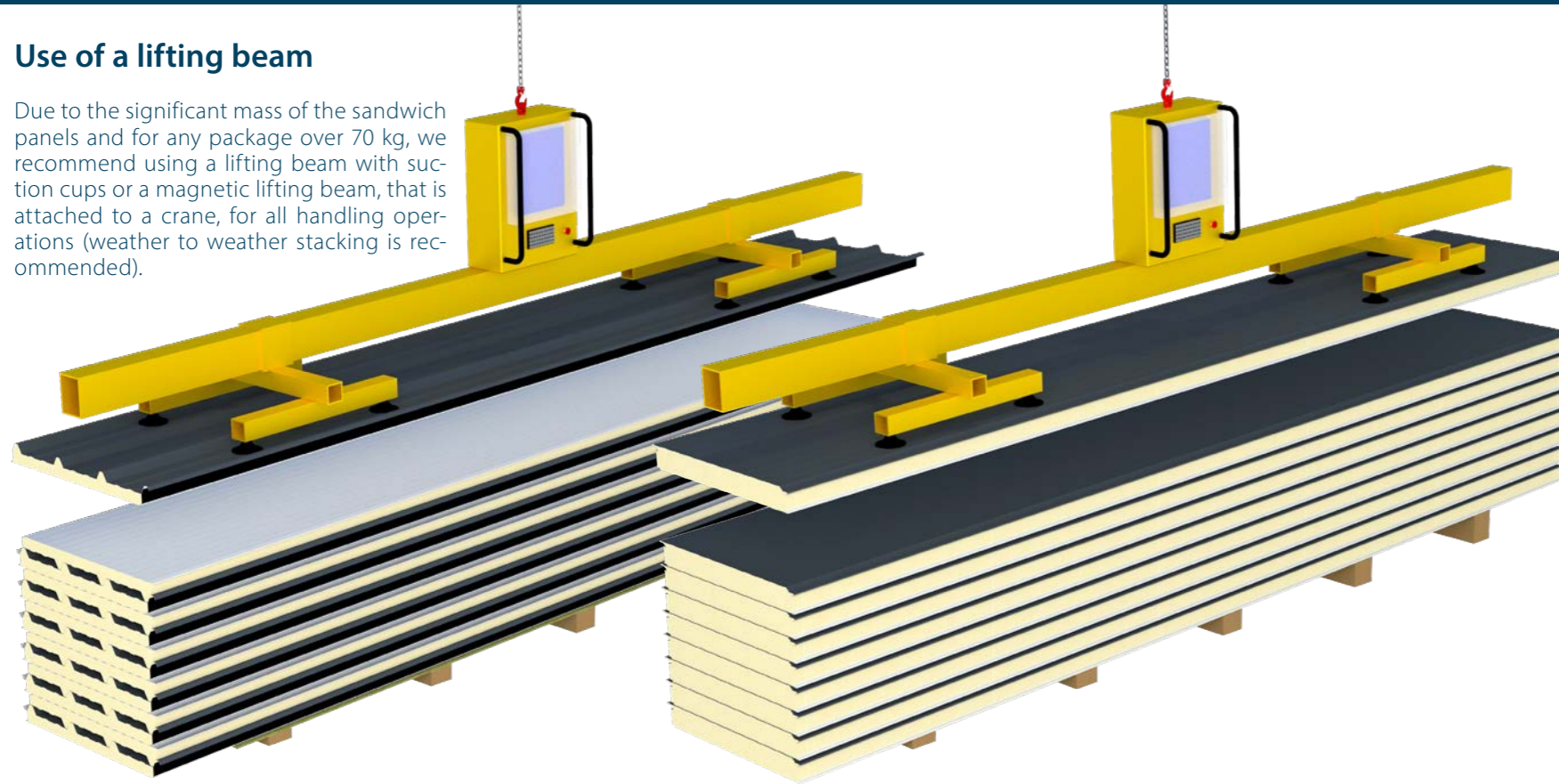

The lifting beam must be centred in relation to the panel's centre of gravity with a minimum grip of 0,15 kg/cm² of the suction cup.

For panels shorter than 10 m, the distance between the attachments is 3 to 5 m.

For lengths exceeding 10 m, the maximum distance between the attachments is 6 m.

In the case of façade/cladding work, the packages must be transported as close as possible to the line/work area to limit handling before their installation.

When working on flat roofs and/or the floors in multi-storey buildings, the packages must be placed on the framework in line with the trusses or porticoes.



The protective film must at least be removed where the suction cup will be placed.

The handling of mineral wool sandwich panels (Vulcasteel range) must be done on the edge, without resting on the interlocking edges.





Jl Wall 1000FC PIR for an office building.



Mineral Wool panels for a factory.



Jl Wall PIR for an agricultural project.



Jl Vulcasteel Wall for an industrial project.



Jl Vulcasteel Roof

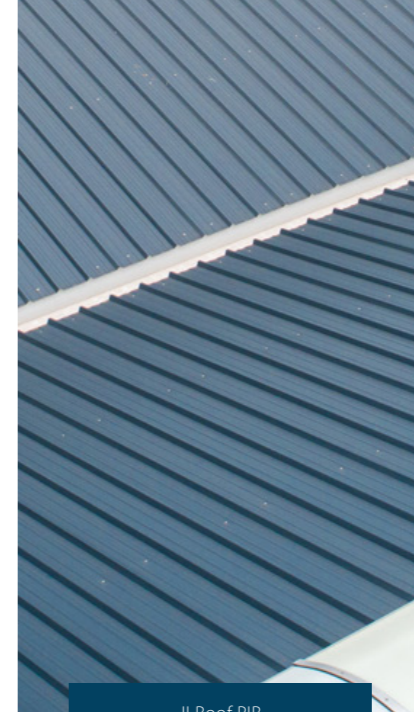

Jl Roof PIR



Jl Wall 1000FC PIR for a sales unit.





JORISIDE

THE STEEL FUTURE

Joris Ide Ltd.

A9, Elmbridge Court,
Gloucester GL3 1JZ, United Kingdom

☎ +44 (0)1452 412 069

☎ +44 (0)1452 358 025

✉ sales@joriside.co.uk

Joris Ide nv/sa

Hille 174,
8750 Zwevezele, Belgium

☎ +32 (0)51 61 07 77

☎ +32 (0)51 61 07 79

✉ info@joriside.be

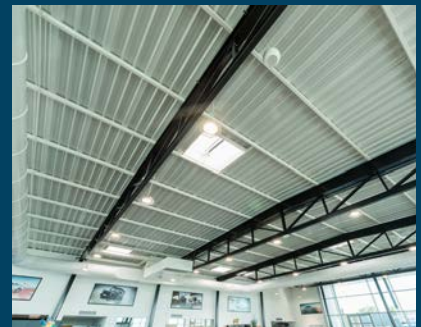

With more than 30 years of experience, Joris Ide represents a guarantee of quality in the construction market. We provide solutions in all fields: acoustic, aesthetic, fire, thermal. Joris Ide, the essential partner for all your projects.